

DEVELON

Wheel Excavator

DX140W-7



Engine

| | |
|---------------------------------------|-------------------------------------|
| Make | DEVELON |
| Model | DL06P |
| Number of cylinders | 6 |
| Rated power, gross (hp per SAE J1995) | 136.8 hp (102 kW) @ 2000 rpm |
| Rated power, net (hp per SAE J1349) | 129.1 hp (96.3 kW) @ 2000 rpm |
| Max. torque, net (SAE J1995) | 434 lb.-ft. (588 Nm) @ 1400 rpm |
| Displacement | 359 in. ³ (5.9 L) |
| Bore and stroke | 3.9 in. x 4.9 in. (100 mm x 125 mm) |
| Starter | 24 V, 8.6 hp (6.0 kW) |
| Battery (qty 2) | 12 V, 150 AH |
| Alternator | 24 V, 80 amp |
| Air cleaner | Three-stage |

Hydraulics

| | |
|--------------------------|-------------------------------|
| Main pumps | 2 x 35.4 gpm (2 x 134 L/min.) |
| Pilot pump (gear design) | 8 gpm (30 L/min.) |

Working Pressure

| | |
|-------------------------------|------------------------------------|
| Boom/arm/bucket (normal mode) | 4975 psi (350 kg/cm ²) |
| Boom/arm/bucket (power boost) | 5265 psi (370 kg/cm ²) |
| Travel | 5265 psi (370 kg/cm ²) |
| Swing | 3916 psi (275 kg/cm ²) |
| Pilot | 580 psi (41 kg/cm ²) |

Tires & Wheels (standard)

| | |
|--------------------|------------------------------|
| Type | Double |
| Tire specification | 10.0 - 20 - 16 PR, OTR, TUBE |
| Rim specification | 7.50 T x 20 |
| Disc offset | 155 mm |

Swing Mechanism

| | |
|--------------|-----------------------------|
| Swing speed | 0 - 12 rpm |
| Swing torque | 27080 lbf.-ft. (3744 kgf-m) |

Drive System

| | |
|--|---|
| Travel speed (creep - low - high) | 2.17 - 5.9 - 21.75 mph (3.5 - 9.5 - 35 km/h) |
| Traction force, max. (drawbar pull) | 16200 lbf.-ft. (7348 kgf-m) |
| Max. grade (limited by engine lubrication) | 58% (30°) |

Environment

| | |
|------------------------------|----------|
| Sound level (2000/14/EC) | 99 dB(A) |
| Cabin sound level (ISO 6396) | 68 dB(A) |

Refill Capacities

| | |
|------------------------------------|--------------------|
| Fuel tank | 72.65 gal. (275 L) |
| DEF tank | 7.9 gal. (30 L) |
| Cooling system (radiator capacity) | 7.77 gal. (29.4 L) |
| Engine oil | 5.81 gal. (22 L) |
| Swing drive | 0.8 gal. (3 L) |
| Front axle | 2.8 gal. (10.5 L) |
| Front hub (2x) | 0.66 gal. (2.5 L) |
| Rear axle | 3.7 gal. (14 L) |
| Rear hub (2x) | 0.66 gal. (2.5 L) |
| Transmission | 0.66 gal. (2.5 L) |
| Hydraulic system | 36.98 gal. (140 L) |
| Hydraulic tank | 23.78 gal. (90 L) |

NOTE: Where applicable, dimensions are in accordance with Society of Automotive Engineers (SAE) and ISO standards. Specifications and design are subject to change without notice. All dimensions are given for DEVELON excavators equipped with standard tracks and the standard front as listed. Pictures of DEVELON excavators may show other than standard equipment. All dimensions are shown in inches. Respective metric dimensions are enclosed by parentheses. Rounding may impact specifications. DEVELON equipment is manufactured with a Quality Management System that is in compliance with ISO 9001:2008.

Technical Specifications

Hydraulic Cylinders

| | Mono Boom (US20/30) | Articulated Boom (US40/50) |
|---|--|--|
| Boom main (2) bore x rod diameter x stroke | 4.3 in. x 3.0 in. x 40.7 in. (110 mm x 75 mm x 1035 mm) | 4.3 in. x 3.0 in. x 38.4 in. (110 mm x 75 mm x 975 mm) |
| Boom articulated (1) bore x rod diameter x stroke | – | 5.5 in. x 3.3 in. x 28.6 in. (140 mm x 85 mm x 727 mm) |
| Arm* (1) bore x rod diameter x stroke | 4.5 in. x 3.1 in. x 43.0 in. (115 mm x 80 mm x 1092 mm) | 4.5 in. x 3.1 in. x 42.9 in. (115 mm x 80 mm x 1089 mm) |
| Bucket (STD) (1) bore x rod diameter x stroke | 3.7 in. x 2.6 in. x 35.4 in. (95 mm x 65 mm x 900 mm) | 3.9 in. x 2.8 in. x 35.4 in. (100 mm x 70 mm x 900 mm) |
| Steering (1) bore x rod diameter x stroke | 4.5 in. x 3.1 in. x 43.6 in. (115 mm x 80 mm x 1108 mm) | |
| Chocking (2) bore x rod diameter x stroke | 3.9 in. x 3.9 in. x 6.0 in. (100 mm x 100 mm x 153 mm) | |
| Stabilizer (2) bore x rod diameter x stroke | 4.3 in. x 2.8 in. x 17.2 in. (110 mm x 70 mm x 438 mm) | |
| Dozer (2) bore x rod diameter x stroke | 3.9 in. x 2.4 in. x 8.0 in. (100 mm x 60 mm x 204 mm) | |
| Outrigger (2 or 4) bore x rod diameter x stroke | 4.3 in. x 2.8 in. x 17.2 in. (110 mm x 70 mm x 438 mm) | |

*Does not include cushioning

The piston rods and cylinder bodies are made of high-strength steel. A shock-absorbing mechanism is fitted in all cylinders to ensure shock-free operation and extended piston life.

Dimensions

| | | Mono Boom Dozer/Outriggers (2 R) (US20) | Outriggers (2 F/2 R) (US30) | Articulated Boom Dozer/Outriggers (2 R) (US40) | Outriggers (2 F/2 R) (US50) |
|-------------------------------|---|--|---------------------------------------|---|---------------------------------------|
| Boom length | | 14' 5" (4400 mm) | | 16' 4" (4988 mm) Lower: 11' 0" (3350 mm), Upper: 6' 7" (2000 mm) | |
| Arm length | | 6' 10" (2100 mm) | | | |
| Bucket type (SAE) (PCSA) | | 0.77 yd ³ (0.59 m ³) | | 0.67 yd ³ (0.51 m ³) | |
| Shipping length | A | 26' 5" (8043 mm) | | 26' 7" (8103 mm) | |
| Shipping width | B | 8' 2" (2495 mm) | | | |
| Shipping height (boom) | C | 9' 8" (2995 mm) | | 8' 10" (2688 mm) | |
| Shipping height (hose) | | 9' 4" (2845 mm) | | 8' 8" (2648 mm) | |
| Overall height – cab | D | 10' 8" (3052 mm) | | | |
| Overall height to guardrail | | 10' 8" (3249 mm) | | | |
| Cabin height above house | | 2' 9" (840 mm) | | | |
| Tail swing radius | E | 9' 0" (2283 mm) | | | |
| Ground clearance | F | 1' 1" (348 mm) | | | |
| Counterweight clearance | G | 4' 0" (1215 mm) | | | |
| Engine cover height | H | 7' 3" (2212 mm) | | | |
| Upper housing width | I | 8' 2" (2490 mm) | | | |
| Wheel base | J | 9' 2" (2800 mm) | | | |
| Tread width | K | 6' 5" (1944 mm) | | | |
| Blade width* | | 8' 2" (2495 mm) | – | 8' 2" (2495 mm) | – |
| Overall undercarriage length* | | 16' 3" (4957 mm) | 16' 5" (4996 mm) | 16' 3" (4957 mm) | 16' 5" (4996 mm) |
| Outrigger length (rear)* | | 3' 8" (1109 mm) | | | |
| Outrigger length (front)* | | – | 3' 7" (1087 mm) | – | 3' 7" (1087 mm) |
| Blade length (front)* | | 3' 5" (1048 mm) | – | 3' 5" (1048 mm) | – |
| Blade clearance (raised)* | | 1' 7" (472 mm) | – | 1' 7" (472 mm) | – |
| Blade height* | | 2' 2" (652 mm) | – | 2' 2" (652 mm) | – |
| Max. blade depth* | | 5" (128 mm) | – | 5" (128 mm) | – |
| Outrigger width (ground)* | | 11' 11" (3631 mm) | | | |
| Outrigger width (max. depth)* | | 11' 2" (3406 mm) | | | |
| Max. outrigger depth* | | -6" (-152 mm) | | | |
| Tire size | | 10.0 – 20 – 16 PR | | | |

*Not shown on diagram

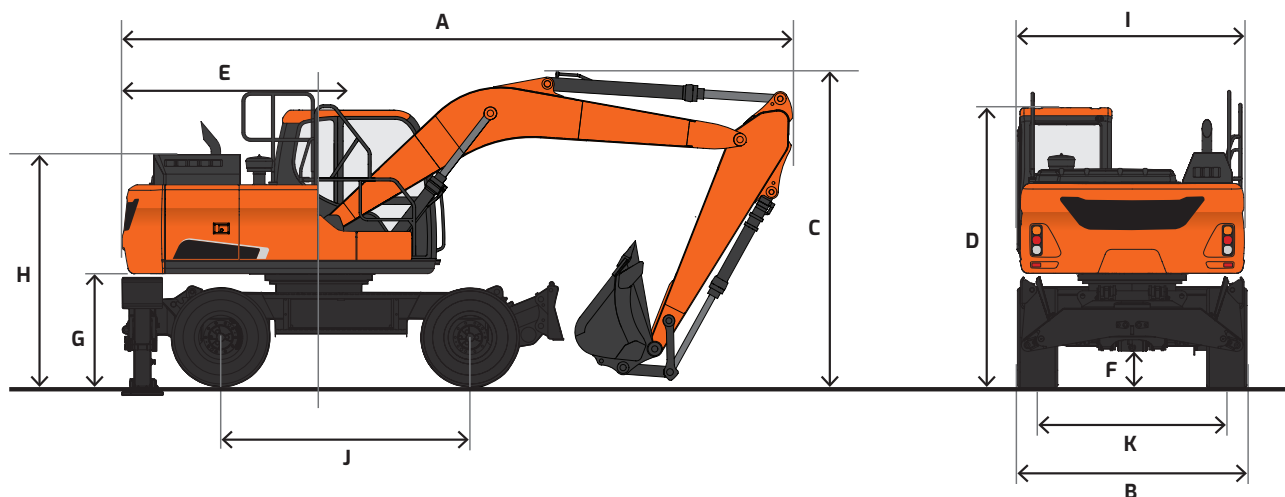

Working Range

| | Mono Boom Dozer/Outriggers (2 R) (US20) | | Outriggers (2 F/2 R) (US30) | Articulated Boom Dozer/Outriggers (2 R) (US40) | | Outriggers(2 F/2 R) (US50) |
|-----------------------------|---|-----------------------|--------------------------------|--|--|-------------------------------|
| | Boom length | 14' 5" (4400 mm) | | | 16' 5" (5009 mm) Lower: 11' 0" (3350 mm) Upper: 6' 7" (2000 mm) | |
| Arm length | 6' 11" (2100 mm) | | | | | |
| Bucket type (SAE, PCSA) | 0.77 yd ³ (0.59 m ³) | | | 0.67 yd ³ (0.51 m ³) | | |
| Max. digging reach | A | 24' 11" (7585 mm) | | 27' 0" (8240 mm) | | |
| Max. digging reach (ground) | B | 24' 2" (7375 mm) | | 26' 5" (8050 mm) | | |
| Max. digging depth | C | 14' 8" (4490 mm) | | 16' 6" (5025 mm) | | |
| Max. loading height | D | 19' 4" (5905 mm) | | 22' 4" (6795 mm) | | |
| Min. loading height | E | 7' 10" (2400 mm) | | 10' 2" (3100 mm) | | |
| Max. digging height | F | 26' 10" (8195 mm) | | 30' 0" (9150 mm) | | |
| Max. bucket pin height | G | 23' 5" (7125 mm) | | 26' 3" (8010 mm) | | |
| Max. vertical wall depth | H | 11' 4" (3445 mm) | | 12' 7" (3840 mm) | | |
| Max. radius vertical | I | 18' 0" (5480 mm) | | 19' 1" (5825 mm) | | |
| Max. depth to 8' line | J | 13' 10" (4215 mm) | | 16' 1" (4905 mm) | | |
| Min. radius to 8' line | K | 6' 11" (2105 mm) | | 2' 10" (865 mm) | | |
| Min. digging reach | L | 18" (455 mm) | | - | | |
| Min. swing radius | M | 7' 8" (2340 mm) | | 8' 3" (2505 mm) | | |
| Digging force, bucket* | SAE | 20238 lbf. (9180 kgf) | | | | |
| Digging force, arm* | | 17086 lbf. (7750 kgf) | | | | |
| Operating weight | 34670 lb. (15726 kg) | | 34811 lb. (15790 kg) | 35025 lb. (15887 kg) | | 35166 lb. (15951 kg) |

*With power boost ON

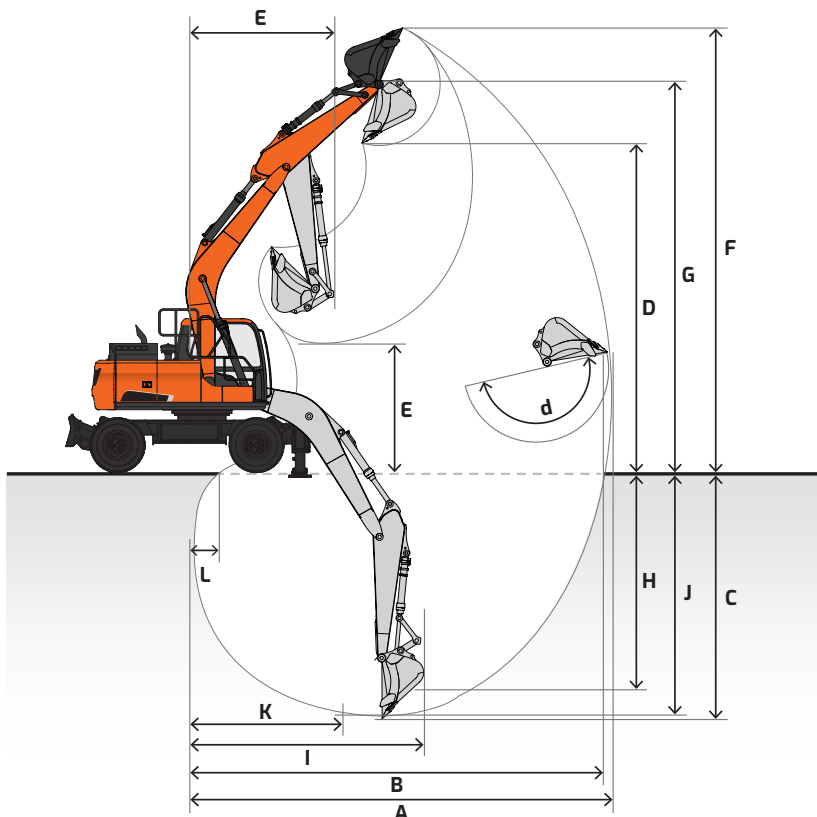











Lifting Capacity

 Rating over front  Rating over side or 360°











DX140W-7 US20

Mono Boom: 14' 5" (4400 mm) | Arm: 6' 11" (2100 mm) | Counterweight: 5500 lb. (2500 kg) | Front & Rear Outriggers UP | Bucket: None | Unit: lb. (kg)

| A (ft. or m) B (ft. or m) | 5' (1.5 m) | | 10' (3.0 m) | | 15' (4.5 m) | | 20' (6.0 m) | | Max. Reach | | |
|------------------------------------|---|---|---|---|---|---|---|---|--|---|--------------------|
| |  |  |  |  |  |  |  |  |  |  | A |
| 20' (6.0 m) | | | | | * 6650 (* 3020) | * 6650 (* 3020) | | | * 6290 (2850) | * 6290 (2850) | 15.13' (4.61 m) |
| 15' (4.5 m) | | | | | * 12130 (* 5500) | 9260 (4200) | | | * 5840 (* 2650) | * 5840 (* 2650) | 18.69' (5.70 m) |
| 10' (3.0 m) | | | * 20480 (* 9290) | 16070 (7290) | * 14360 (* 6510) | 8880 (4030) | * 7900 (* 3580) | 5850 (2650) | * 5950 (* 2700) | 5660 (2570) | 20.44' (6.23 m) |
| 5' (1.5 m) | | | * 24100 (* 10930) | 14840 (6730) | * 16200 (* 7350) | 8450 (3830) | 10480 (4750) | 5700 (2590) | * 6490 (* 2940) | 5370 (2430) | 20.88' (6.36 m) |
| Ground Level | | | * 24830 (11260) | 14460 (6560) | 16120 (7310) | 8180 (3710) | * 8250 (* 3740) | 5600 (2540) | * 7690 (* 3490) | 5580 (2530) | 20.07' (6.12 m) |
| -5' (-1.5 m) | * 18990 (* 8610) | * 18990 (* 8610) | * 21580 (* 9790) | 14510 (6580) | * 14880 (* 6750) | 8150 (3700) | | | * 10530 (* 4780) | 6520 (2960) | 17.84' (5.44 m) |
| -10' (-3.0 m) | | | * 14190 (* 6440) | * 14190 (* 6440) | | | | | * 10090 (* 4580) | 9690 (4400) | 13.51' (5.44 m) |

DX140W-7 US20

Mono Boom: 14' 5" (4400 mm) | Arm: 6' 11" (2100 mm) | Counterweight: 5500 lb. (2500 kg) | Front & Rear Outriggers DOWN | Bucket: None | Unit: lb. (kg)

| A (ft. or m) B (ft. or m) | 5' (1.5 m) | | 10' (3.0 m) | | 15' (4.5 m) | | 20' (6.0 m) | | Max. Reach | | |
|------------------------------------|---|---|---|---|---|---|---|---|--|---|--------------------|
| |  |  |  |  |  |  |  |  |  |  | A |
| 20' (6.0 m) | | | | | * 6650 (* 3020) | * 6650 (* 3020) | | | * 6290 (* 2850) | * 6290 (* 2850) | 15.13' (4.61 m) |
| 15' (4.5 m) | | | | | * 12130 (* 5500) | * 12130 (* 5500) | | | * 5840 (* 2650) | * 5840 (* 2650) | 18.69' (5.70 m) |
| 10' (3.0 m) | | | * 20480 (* 9290) | * 20480 (* 9290) | * 14360 (* 6510) | * 14360 (* 6510) | * 7900 (* 3580) | * 7900 (* 3580) | * 5950 (* 2700) | * 5950 (* 2700) | 20.44' (6.23 m) |
| 5' (1.5 m) | | | * 24100 (* 10930) | * 24100 (* 10930) | * 16200 (* 7350) | 14240 (6460) | * 10970 (* 4980) | 9270 (4210) | * 6490 (* 2940) | * 6490 (* 2940) | 20.88' (6.36 m) |
| Ground Level | | | * 24830 (* 11260) | * 24830 (* 11260) | * 16670 (* 7560) | 13930 (6320) | * 8250 (* 3740) | * 8250 (* 3740) | * 7690 (* 3490) | * 7690 (* 3490) | 20.07' (6.12 m) |
| -5' (-1.5 m) | * 18990 (* 8610) | * 18990 (* 8610) | * 21580 (* 9790) | * 21580 (* 9790) | * 14880 (* 6750) | 13890 (6300) | | | * 10530 (* 4780) | * 10530 (* 4780) | 17.84' (5.44 m) |
| -10' (-3.0 m) | | | * 14190 (* 6440) | * 14190 (* 6440) | | | | | * 10090 (* 4580) | * 10090 (* 4580) | 13.51' (4.12 m) |

A Distance from center of rotation
B Height

NOTE: Lifting capacities are in compliance with SAE 1097 and ISO 10567. Machine in lifting mode with power boost turned on. Load point is the end of the arm. Rated loads shown do not exceed 75% of minimum tipping loads or 87% of hydraulic capacities. Rated loads marked with an asterisk (*) are limited by hydraulic capacities. The least stable position is over the side. The total mass of machine includes the mass of the boom, arm, counterweight, all operating fluids and 165 lb. (75 kg) operator.

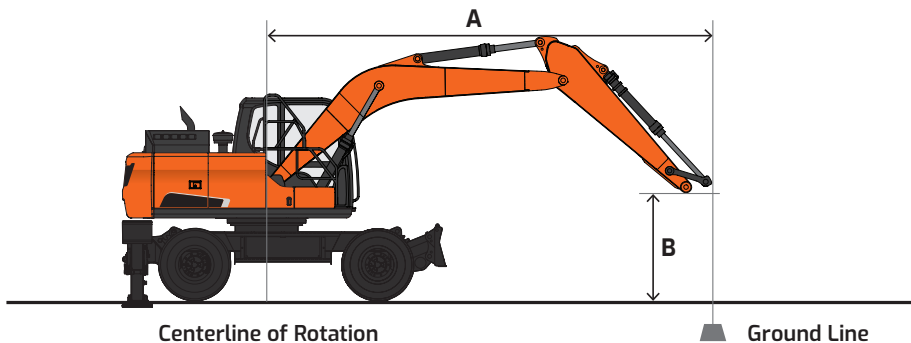











Lifting Capacity

 Rating over front  Rating over side or 360°











DX140W-7 US30

Mono Boom: 14' 5" (4400 mm) | Arm: 6' 11" (2100 mm) | Counterweight: 5500 lb. (2500 kg) | Front & Rear Outriggers UP | Bucket: None | Unit: lb. (kg)

| A (ft. or m) B (ft. or m) | 5' (1.5 m) | | 10' (3.0 m) | | 15' (4.5 m) | | 20' (6.0 m) | | Max. Reach | | |
|------------------------------------|---|---|---|---|---|---|---|---|--|---|--------------------|
| |  |  |  |  |  |  |  |  |  |  | A |
| 20' (6.0 m) | | | | | * 6650 (* 3020) | * 6650 (* 3020) | | | * 6290 (* 2850) | * 6290 (* 2850) | 15.13' (4.61 m) |
| 15' (4.5 m) | | | | | * 12130 (* 5500) | 9420 (4270) | | | * 5840 (* 2650) | * 5840 (* 2650) | 18.69' (5.70 m) |
| 10' (3.0 m) | | | * 20480 (* 9290) | 16350 (7420) | * 14360 (* 6510) | 9050 (4100) | * 7900 (* 3580) | 5970 (2710) | * 5950 (* 2700) | 5770 (2620) | 20.44' (6.23 m) |
| 5' (1.5 m) | | | * 24100 (* 10930) | 15130 (6860) | * 16200 (* 7350) | * 8620 (3910) | 10350 (4700) | 5820 (2640) | * 6490 (* 2940) | 5480 (2480) | 20.88' (6.36 m) |
| Ground Level | | | * 24830 (* 11260) | 14740 (6690) | 15940 (7230) | 8350 (3790) | * 8250 (* 3740) | 5720 (2590) | * 7690 (* 3490) | 5690 (2580) | 20.07' (6.12 m) |
| -5' (-1.5 m) | * 18990 (* 8610) | * 18990 (* 8610) | * 21580 (* 9790) | 14800 (6710) | * 14880 (* 6750) | 8310 (3770) | | | * 10530 (* 4780) | 6650 (3020) | 17.84' (5.44 m) |
| -10' (-3.0 m) | | | * 14190 (* 6440) | * 14190 (* 6440) | | | | | * 10090 (* 4580) | 9880 (4480) | 13.51' (4.12 m) |

DX140W-7 US30

Mono Boom: 14' 5" (4400 mm) | Arm: 6' 11" (2100 mm) | Counterweight: 5500 lb. (2500 kg) | Front & Rear Outriggers DOWN | Bucket: None | Unit: lb. (kg)

| A (ft. or m) B (ft. or m) | 5' (1.5 m) | | 10' (3.0 m) | | 15' (4.5 m) | | 20' (6.0 m) | | Max. Reach | | |
|------------------------------------|---|---|---|---|---|---|---|---|--|---|--------------------|
| |  |  |  |  |  |  |  |  |  |  | A |
| 20' (6.0 m) | | | | | * 6650 (* 3020) | * 6650 (* 3020) | | | * 6290 (* 2850) | * 6290 (* 2850) | 15.13' (4.61 m) |
| 15' (4.5 m) | | | | | * 12130 (* 5500) | * 12130 (* 5500) | | | * 5840 (* 2650) | * 5840 (* 2650) | 18.69' (5.70 m) |
| 10' (3.0 m) | | | * 20480 (* 9290) | * 20480 (* 9290) | * 14360 (* 6510) | * 14360 (* 6510) | * 7900 (* 3580) | * 7900 (* 3580) | * 5950 (* 2700) | * 5950 (* 2700) | 20.44' (6.23 m) |
| 5' (1.5 m) | | | * 24100 (* 10930) | * 24100 (* 10930) | * 16200 (* 7350) | * 16200 (* 7350) | * 10970 (* 4980) | * 10970 (* 4980) | * 6490 (* 2940) | * 6490 (* 2940) | 20.88' (6.36 m) |
| Ground Level | | | * 24830 (* 11260) | * 24830 (* 11260) | * 21580 (* 7560) | * 21580 (* 7560) | * 14880 (* 3740) | * 14880 (* 3740) | * 10530 (* 3490) | * 10530 (* 3490) | 20.07' (6.12 m) |
| -5' (-1.5 m) | * 18990 (* 8610) | * 18990 (* 8610) | * 21580 (* 9790) | * 21580 (* 9790) | * 14880 (* 6750) | * 14880 (* 6750) | | | * 10530 (* 4780) | * 10530 (* 4780) | 17.84' (5.44 m) |
| -10' (-3.0 m) | | | * 14190 (* 6440) | * 14190 (* 6440) | | | | | * 10090 (* 4580) | * 10090 (* 4580) | 13.51' (4.12 m) |

A Distance from center of rotation
B Height

NOTE: Lifting capacities are in compliance with SAE 1097 and ISO 10567. Machine in lifting mode with power boost turned on. Load point is the end of the arm. Rated loads shown do not exceed 75% of minimum tipping loads or 87% of hydraulic capacities. Rated loads marked with an asterisk (*) are limited by hydraulic capacities. The least stable position is over the side. The total mass of machine includes the mass of the boom, arm, counterweight, all operating fluids and 165 lb. (75 kg) operator.

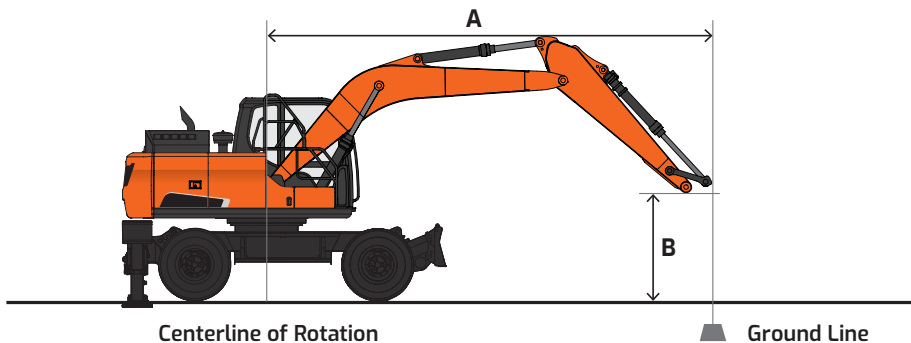











Lifting Capacity

 Rating over front  Rating over side or 360°











DX140W-7 US40

2-PC Boom: 16' 4" (5000 mm) | Arm: 6' 11" (2100 mm) | Counterweight: 5500 lb. (2500 kg) | Front & Rear Outriggers UP | Bucket: None | Unit: lb. (kg)

| A (ft. or m) B (ft. or m) | 5' (1.5 m) | | 10' (3.0 m) | | 15' (4.5 m) | | 20' (6.0 m) | | Max. Reach | | |
|------------------------------------|---|---|---|---|---|---|---|---|--|---|--------------------|
| |  |  |  |  |  |  |  |  |  |  | |
| 25' (7.5 m) | | | | | | | | | * 8700 (* 3950) | * 8700 (* 3950) | 12.34' (3.76 m) |
| 20' (6.0 m) | | | | | * 10400 (* 4720) | 9400 (4720) | | | * 7230 (* 3280) | 6990 (3280) | 17.98' (5.48 m) |
| 15' (4.5 m) | | | * 14420 (* 6540) | * 14420 (* 6540) | * 11400 (* 5170) | 9120 (4145) | * 9800 (* 4440) | 5860 (2664) | * 6870 (* 3110) | 5380 (2445) | 21.06' (6.42 m) |
| 10' (3.0 m) | | | | | * 13530 (* 6130) | 8560 (3891) | 10570 (4920) | 5680 (2582) | * 6980 (* 3170) | 4710 (2141) | 22.63' (6.90 m) |
| 5' (1.5 m) | | | | | * 15490 (* 7030) | 8030 (3650) | 10310 (5270) | 5460 (2482) | * 7510 (* 3410) | 4480 (2036) | 23.02' (7.02 m) |
| Ground Level | | | | | * 15760 (* 7320) | 7760 (3527) | 10140 (5390) | 5310 (2414) | * 8620 (* 3910) | 4610 (2096) | 22.29' (6.79 m) |
| -5' (-1.5 m) | | | * 21300 (* 9660) | 13900 (9660) | * 15180 (* 6890) | 7730 (3514) | 10150 (4900) | 5330 (2423) | 9940 (4760) | 5230 (2377) | 20.32' (6.19 m) |

DX140W-7 US40

2-PC Boom: 16' 4" (5000 mm) | Arm: 6' 11" (2100 mm) | Counterweight: 5500 lb. (2500 kg) | Front & Rear Outriggers DOWN | Bucket: None | Unit: lb. (kg)

| A (ft. or m) B (ft. or m) | 5' (1.5 m) | | 10' (3.0 m) | | 15' (4.5 m) | | 20' (6.0 m) | | Max. Reach | | |
|------------------------------------|---|---|---|---|---|---|---|---|--|---|--------------------|
| |  |  |  |  |  |  |  |  |  |  | |
| 25' (7.5 m) | | | | | | | | | * 8700 (* 3950) | * 8700 (* 3950) | 12.34' (3.76 m) |
| 20' (6.0 m) | | | | | * 10400 (* 4720) | * 10400 (* 4720) | | | * 7230 (* 3280) | * 7230 (* 3280) | 17.98' (5.48 m) |
| 15' (4.5 m) | | | * 14420 (* 6540) | * 14420 (* 6540) | * 11400 (* 5170) | * 11400 (* 5170) | * 9800 (* 4440) | 9530 (4320) | * 6870 (* 3110) | * 6870 (* 3110) | 21.06' (6.42 m) |
| 10' (3.0 m) | | | | | * 13530 (* 6130) | * 13530 (* 6130) | * 10840 (* 4920) | 9330 (4230) | * 6980 (* 3170) | * 6980 (* 3170) | 22.63' (6.90 m) |
| 5' (1.5 m) | | | | | * 15490 (* 7030) | 13870 (6290) | * 11630 (* 5270) | 9080 (4120) | * 7510 (* 3410) | 7410 (3360) | 23.02' (7.02 m) |
| Ground Level | | | | | * 16150 (* 7320) | 13550 (6140) | * 11880 (* 5390) | 8920 (4050) | * 8620 (* 3910) | 7680 (3480) | 22.29' (6.79 m) |
| -5' (-1.5 m) | | | * 21300 (* 9660) | * 21300 (* 9660) | * 15180 (* 6890) | 13520 (6130) | * 10800 (* 4900) | 8940 (4050) | * 10490 (* 4760) | 8750 (3970) | 20.32' (6.19 m) |

A Distance from center of rotation
B Height

NOTE: Lifting capacities are in compliance with SAE 1097 and ISO 10567. Machine in lifting mode with power boost turned on. Load point is the end of the arm. Rated loads shown do not exceed 75% of minimum tipping loads or 87% of hydraulic capacities. Rated loads marked with an asterisk (*) are limited by hydraulic capacities. The least stable position is over the side. The total mass of machine includes the mass of the boom, arm, counterweight, all operating fluids and 165 lb. (75 kg) operator.

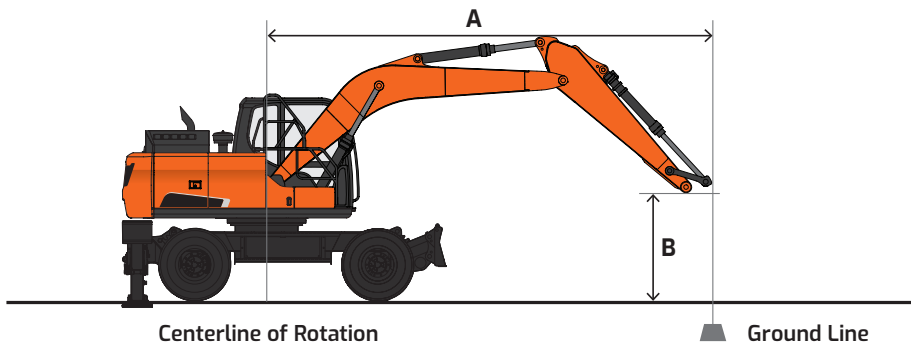











Lifting Capacity

 Rating over front  Rating over side or 360°











DX140W-7 US50

2-PC Boom: 16' 4" (5000 mm) | Arm: 6' 11" (2100 mm) | Counterweight: 5500 lb. (2500 kg) | Front & Rear Outriggers UP | Bucket: None | Unit: lb. (kg)

| A (ft. or m) B (ft. or m) | 5' (1.5 m) | | 10' (3.0 m) | | 15' (4.5 m) | | 20' (6.0 m) | | Max. Reach | | |
|------------------------------------|---|---|---|---|---|---|---|---|--|---|--------------------|
| |  |  |  |  |  |  |  |  |  |  | |
| 25' (7.5 m) | | | | | | | | | * 8700 (* 3950) | * 8700 (* 3950) | 12.34' (3.76 m) |
| 20' (6.0 m) | | | | | * 10400 (* 4720) | 9560 (4340) | | | * 7230 (* 3280) | 7120 (3230) | 17.98' (5.48 m) |
| 15' (4.5 m) | | | * 14420 (* 6540) | * 14420 (* 6540) | * 11400 (* 5170) | 9280 (4210) | * 9800 (* 4440) | 5980 (2710) | * 6870 (* 3110) | 5490 (2490) | 21.06' (6.42 m) |
| 10' (3.0 m) | | | | | * 13530 (* 6130) | 8730 (3960) | 10450 (4740) | 5800 (2630) | * 6980 (* 3170) | 4810 (2180) | 22.63' (6.90 m) |
| 5' (1.5 m) | | | | | * 15490 (* 7030) | 8200 (3720) | 10180 (4620) | 5570 (2530) | * 7510 (* 3410) | 4580 (2080) | 23.02' (7.02 m) |
| Ground Level | | | | | 15570 (7060) | 7920 (3590) | 10010 (4540) | 5430 (2460) | 8570 (3890) | 4720 (2140) | 22.29' (6.79 m) |
| -5' (-1.5 m) | | | * 21300 (* 9660) | 14190 (6440) | * 15180 (* 6890) | 7890 (3580) | 10030 (4550) | 5440 (2470) | 9820 (4450) | 5340 (2420) | 20.32' (6.19 m) |

DX140W-7 US50

2-PC Boom: 16' 4" (5000 mm) | Arm: 6' 11" (2100 mm) | Counterweight: 5500 lb. (2500 kg) | Front & Rear Outriggers DOWN | Bucket: None | Unit: lb. (kg)

| A (ft. or m) B (ft. or m) | 5' (1.5 m) | | 10' (3.0 m) | | 15' (4.5 m) | | 20' (6.0 m) | | Max. Reach | | |
|------------------------------------|---|---|---|---|---|---|---|---|--|---|--------------------|
| |  |  |  |  |  |  |  |  |  |  | |
| 25' (7.5 m) | | | | | | | | | * 8700 (* 3950) | * 8700 (* 3950) | 12.34' (3.76 m) |
| 20' (6.0 m) | | | | | * 10400 (* 4720) | * 10400 (* 4720) | | | * 7230 (* 3280) | * 7230 (* 3280) | 17.98' (5.48 m) |
| 15' (4.5 m) | | | * 14420 (* 6540) | * 14420 (* 6540) | * 11400 (* 5170) | * 11400 (* 5170) | * 9800 (* 4440) | * 9800 (* 4440) | * 6870 (* 3110) | * 6870 (* 3110) | 21.06' (6.42 m) |
| 10' (3.0 m) | | | | | * 13530 (* 6130) | * 13530 (* 6130) | * 10840 (* 4920) | * 10840 (* 4920) | * 6980 (* 3170) | * 6980 (* 3170) | 22.63' (6.90 m) |
| 5' (1.5 m) | | | | | * 15490 (* 7030) | * 15490 (* 7030) | * 11630 (* 5270) | 11130 (5050) | * 7510 (* 3410) | * 7510 (* 3410) | 23.02' (7.02 m) |
| Ground Level | | | | | * 16150 (* 7320) | * 16150 (* 7320) | * 11880 (* 5390) | 10960 (4970) | * 8620 (* 3910) | * 8620 (* 3910) | 22.29' (6.79 m) |
| -5' (-1.5 m) | | | * 21300 (* 9660) | * 21300 (* 9660) | * 15180 (* 6890) | * 15180 (* 6890) | * 10800 (* 4900) | * 10800 (* 4900) | * 10490 (* 4760) | * 10490 (* 4760) | 20.32' (6.19 m) |

A Distance from center of rotation
B Height

NOTE: Lifting capacities are in compliance with SAE 1097 and ISO 10567. Machine in lifting mode with power boost turned on. Load point is the end of the arm. Rated loads shown do not exceed 75% of minimum tipping loads or 87% of hydraulic capacities. Rated loads marked with an asterisk (*) are limited by hydraulic capacities. The least stable position is over the side. The total mass of machine includes the mass of the boom, arm, counterweight, all operating fluids and 165 lb. (75 kg) operator.

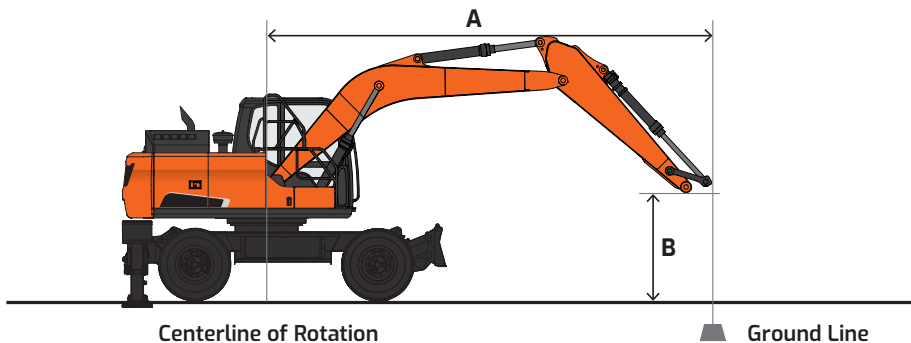

Standard & Optional Equipment

■ Standard ● Optional

Engine

| | |
|---|-----|
| Emissions (EPA) | T4f |
| High-pressure common-rail (HPCR) | ■ |
| Turbo waste gate (WGT) | ■ |
| Cooled exhaust gas recirculation (CEGR) | ■ |
| Diesel oxidation catalyst (DOC) | ■ |
| Selective catalyst reduction (SCR) | ■ |
| Diesel exhaust fluid (DEF) | ■ |
| Fuel filter with water separator | ■ |
| Variable speed cooling fan (engine-driven with electric clutch) | ■ |
| Coolant expansion tank | ■ |
| Dual element dry-type air filter with evacuator | ■ |
| Precleaner | ■ |
| Electronic engine control (ECU) | ■ |
| Auto idle | ■ |
| Auto shutdown (time-adjustable) | ■ |
| Overheat & low oil pressure engine protection | ■ |
| Block heater (110 V), diesel-powered coolant heater | ● |
| Water separator with heater | ● |
| Fuel filler pump | ● |

Hydraulic

| | |
|---|---|
| Electronic Power Optimizing System (EPOS) | ■ |
| Variable axial piston main pump (tandem) | ■ |
| Cross-sensing pump control | ■ |
| Pilot-operated control valves | ■ |
| Gear pilot pump | ■ |
| Smart Power Control (SPC) | ■ |
| Axial piston swing motor | ■ |
| Spring-applied hydraulic release brake, travel | ■ |
| Spring-applied hydraulic release brake, swing motor | ■ |
| Axial piston travel motor (high/low, auto) | ■ |
| Auxiliary hydraulics, one- & two-way piping | ■ |
| Auxiliary hydraulics, tilt/rotate piping | ● |
| Adjustable auxiliary flow & pressure, 10 presets | ■ |
| Intelligent floating boom | ● |
| Boom & arm lock valves | ● |
| Clamshell piping | ● |

Controls

| | |
|---|---|
| Steering wheel | ■ |
| Accelerator pedal | ■ |
| Brake pedal | ■ |
| Swing lock mechanism for traveling | ■ |
| Fine swing control | ■ |
| Joystick controls | ■ |
| Pattern control change valve (SAE, ISO BHL) | ■ |
| Joystick attachment control | ■ |
| Switches/buttons | ■ |
| - Right (one-way, two-way, power boost) | ■ |
| - Left (tilt/rotate, horn, one-touch decel) | ■ |
| Foot pedal attachment control | ■ |
| Control stands | ■ |
| - Height adjustable | ■ |
| - Sliding (fore/aft) | ■ |
| - Tilting armrests | ■ |
| Engine speed control dial | ■ |
| Switches & indicators, steering column | ■ |
| - Steering column | ■ |
| - Turn signal/hazard postional lever | ■ |
| - Work/travel selector switch | ■ |
| - Wiper & washer control | ■ |
| - Turn signal control lever | ■ |
| - Horn button | ■ |
| - Hazard warning switch | ■ |
| - High/low beam control | ■ |
| Switches, console-mounted | ■ |
| - Starter button switch | ■ |
| - Work light | ■ |
| - Travel speed selector | ■ |
| - Auxiliary mode switch | ■ |
| Emergency stop switch | ■ |
| Power modes (P+, P, S, E) | ■ |
| Work modes (digging, lifting, breaker, shear) | ■ |
| Jog dial display control | ■ |
| Wiper control panel | ■ |
| Audio control panel | ■ |

Cabin

| | |
|--|---|
| Steel, all-weather & sound-suppressed | ■ |
| ROPS (ISO 12117-2:2008) | ■ |
| Viscous mount with spring reinforcement | ■ |
| Front window panto wiper with wiper/washer | ■ |
| Tinted safety glass | ■ |
| Skylight top hatch with sun screen | ■ |
| Front window with sun screen | ■ |
| Visor – front window skylight & rear window | ■ |
| Pull-up type top front window | ■ |
| Removable lower front window with storage behind seat | ■ |
| Adjustable sliding side door window | ■ |
| Defrost, front window | ■ |
| Lockable doors | ■ |
| Seat | ■ |
| - Heated | ■ |
| - Air suspension | ■ |
| - 2" (51 mm) seat belt | ■ |
| - Adjustable height & recline | ■ |
| - Adjustable fore/aft | ■ |
| - Adjustable armrests | ■ |
| Leatherette seat | ■ |
| - Heating & cooling | ■ |
| - Air suspension | ■ |
| - 2" (51 mm) seat belt | ● |
| - Adjustable height & recline | ● |
| - Adjustable fore/aft | ● |
| - Adjustable armrests | ● |
| 3" (76 mm) seat belt | ● |
| Control stands | ■ |
| - Height adjustable | ■ |
| - Mounted to seat base | ■ |
| Foot rest | ■ |
| Storage for operator's manuals | ■ |
| Rearview mirrors | ■ |
| Fully automatic HVAC with radiant temperature sensor | ■ |
| 8" multi-function LCD interactive display monitor | ■ |
| Cigarette lighter | ■ |
| Digital audio broadcasting radio with cell phone integration | ■ |
| Speakers (2) | ■ |
| Antenna, roof-mounted | ■ |
| Emergency breakout tool | ■ |
| Hot/cold beverage compartment | ■ |
| Power socket, 12 V & 24 V | ■ |
| Front & rear cup holders | ■ |
| Interior light | ■ |
| Coat hanger | ■ |
| Rain shield | ● |
| Fog guard | ● |
| Front window guard | ● |

Electrical

| | |
|--|---|
| System voltage – 24 V | ■ |
| Alternator – 24 V, 80 amp | ■ |
| 2 x 12 V batteries, 150 AH reserve capacity, 950 CCA | ■ |
| Blade-type fuse panel | ■ |
| Main circuit breaker | ■ |
| Light, work (LED): machine (2), boom (2) | ■ |
| Light, work (LED): 6 cab top, front (4), rear (2) | ● |
| Light, work (LED): 4 cab top, front (2), rear (2) | ● |
| Rotating beacon | ● |
| Hour meter | ■ |
| Engine restart prevention system | ■ |
| Side view camera with LED lamps (3) | ■ |
| Rearview camera with LED lamps (3) | ■ |
| 360° all-around view camera | ● |
| Microphone & speaker | ● |
| Ultrasonic sensor | ● |
| Laptop service port | ■ |
| Self-diagnostics system | ■ |
| Smart key (remote ignition key) | ■ |
| DEVELON Fleet Management | ■ |

Display Monitor & Warnings

| | |
|--|---|
| Indicators | ■ |
| - Work modes (P+, P, S, E) | ■ |
| - User/Service menu | ■ |
| Gauges | ■ |
| - Fuel level | ■ |
| - DEF level | ■ |
| - Engine coolant temperature | ■ |
| - Hydraulic oil temperature | ■ |
| - Engine rpm | ■ |
| - Battery voltage | ■ |
| - Hydraulic pump pressure | ■ |
| - ECO | ■ |
| - Digital clock | ■ |
| - Trip meter | ■ |
| - Hour meter | ■ |
| - Fuel consumption | ■ |
| Warning & indicator lights | ■ |
| - Seat belt | ■ |
| - Error code | ■ |
| - SCR warning | ■ |
| - Check engine | ■ |
| - Engine oil pressure | ■ |
| - Engine pre-heat engaged | ■ |
| - Radiator coolant level & temperature | ■ |
| - Air filter | ■ |
| - Fuel level | ■ |
| - DEF level – low | ■ |
| - Water in fuel | ■ |
| - Battery charge | ■ |
| - Work lights on | ■ |
| - Hydraulic oil temperature | ■ |
| - Hydraulic charge pressure | ■ |
| - Hydraulic pilot filter | ■ |
| - Hydraulic return filter | ■ |
| Swing alarm | ■ |
| Travel alarm | ■ |
| Buzzer | ■ |
| - Engine oil pressure | ■ |
| - Coolant temperature | ■ |

Undercarriage

| | |
|---|---|
| Tire size – 10.0 – 20 – 16 ply rating | ■ |
| Transmission 2-speed power-shift with creep | ■ |
| Planetary drive front & rear axle | ■ |
| Oscillating (±8°) front axle lockable | ■ |
| Steering front axle | ■ |
| Dozer | ■ |
| Outriggers, front (in place of dozer) | ● |
| Outriggers, rear | ■ |
| Toolbox | ■ |

Other

| | |
|--|---|
| Centralized lubrication | ■ |
| - Boom | ■ |
| - Swing | ■ |
| Emergency steering | ■ |
| Handrails & service platforms | ■ |
| Skid-resistant steps & service platforms | ■ |
| Wheel chocks | ■ |
| Manuals | ■ |
| - Operation & Maintenance | ■ |
| - Parts | ■ |
| - AEM Safety Manual | ■ |
| DEVELON Fleet Management 3-year subscription | ■ |
| Vandalism protection | ■ |
| - Lockable panels | ■ |
| - Lockable fluid fill points | ■ |
| - Anti-theft protection (password) | ■ |
| - Vandalism window cover mount | ■ |
| Air compressor | ● |

Certain specification(s) are based on engineering calculations and are not actual measurements. Specification(s) are provided for comparison purposes only and are subject to change without notice. Specification(s) for your individual DEVELON equipment will vary based on normal variations in design, manufacturing, operating conditions, and other factors. Pictures of DEVELON units may show other than standard equipment.

Powered by Innovation

DEVELON

A brand of HD Hyundai Infracore.

na.develon-ce.com/dx140w-7

DX140W-7 Wheel Excavator Spec Sheet
Printed in the U.S.A.
23906_001_D061923

©2023 HD Hyundai Infracore. All rights reserved.