

DEVELON

Dozer

DD130



Engine

Make	PERKINS
Model	1204J
Number of cylinders	4
Rated power, gross (hp per SAE J1995)	156.9 hp (117.0 kW) @ 2200 rpm
Rated power, net (hp per SAE J1349)	145.8 hp (108.7 kW) @ 2200 rpm
Maximum torque, net (SAE J1995)	524 lbf. ft. (710 N·m) @ 1400 rpm
Displacement	269 in. ³ (4.4 L)
Bore and stroke	4.1 in. x 5.0 in. (105 mm x 127 mm)
Starter	24 V, 10.5 hp (7.8 kW)
Battery (qty 2)	12 V, 100 AH
Alternator	24 V, 100 amp
Air cleaner	Dual element

Hydraulics

Main pump	35 gpm (132 L/min)
Relief pressure (normal)	3844 psi (265 bar)

Undercarriage

Upper rollers (each track)	2
Lower rollers (each track)	8
Number of shoes (links per side)	41

Drive System

Travel speed (F/R)	5.6 mph (9.0 km/h)
Max. traction force (drawbar pull)	48.5 kipf (22.0 ton.f)

Environment

Sound level (2000/14/EC)	106 dB(A)
Cabin sound level (ISO 6396)	76 dB(A)

Refill Capacities

Fuel tank	50.0 gal. (190.0 L)
DEF tank	5.0 gal. (19.0 L)
Cooling system (radiator capacity)	11.8 gal. (44.6 L)
Engine oil	3.3 gal. (12.4 L)
Final drive (each side)	1.2 gal. (4.5 L)
Hydraulic tank	20.0 gal. (74.0 L)

Hydraulic Cylinders

Blade lift (2) bore x rod diameter x stroke	3.94 in. x 2.17 in. x 14.3 in. (100 mm x 55 mm x 362 mm)
Blade angle (2) bore x rod diameter x stroke	3.54 in. x 1.97 in. x 18.15 in. (90 mm x 50 mm x 461 mm)
Blade rotate (1) bore x rod diameter x stroke	4.33 in. x 2.56 in. x 5.51 in. (110 mm x 65 mm x 140 mm)
Ripper lift bore x rod diameter x stroke	4.92 in. x 2.76 in. x 14.25 in. (125 mm x 70 mm x 362 mm)

The piston rods and cylinder bodies are made of high-strength steel.

Dimensions

		XL Blade	LGP Blade
Blade type		XL	LGP
Overall shipping length	A ₁	16' 6" (5035 mm)	
Overall shipping length (w/ ripper)	A ₂	19' 9" (6030 mm)	
Overall shipping height	B	10' 3" (3130 mm)	
Overall shipping width (blade straight)	C	10' 2" (3105 mm)	11' 12" (3655 mm)
Tumbler length	D	8' 11" (2720 mm)	
Overall track length	E	12' 1" (3690 mm)	
Undercarriage width	F	8' 5" (2560 mm)	9' 1" (2760 mm)
Track gauge width	G	6' 7" (2000 mm)	
Track grouser width	H	22" (560 mm)	30" (760 mm)
Ground clearance	I	14" (355 mm)	

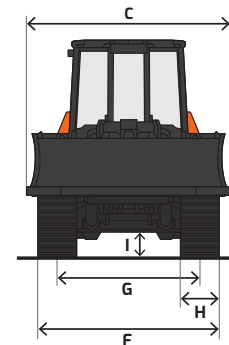
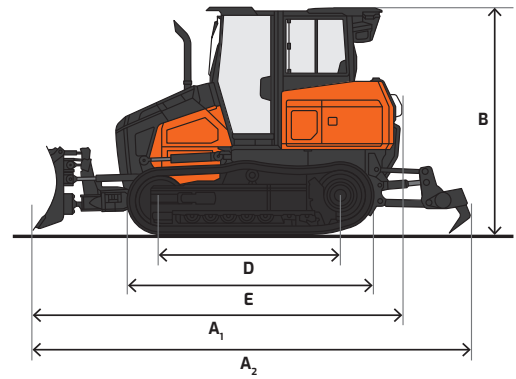

Working Range

		XL Blade	LGP Blade
Blade type		XL	LGP
Blade capacity (SAE)		4.6 yd ³ (3.5 m ³)	5.5 yd ³ (4.2 m ³)
Blade width	A ₁	122.2' (3105 mm)	143.9' (3655 mm)
Blade width, max. angle	A ₂	113' (2870 mm)	132.7' (3370 mm)
Blade height	B	43.9' (1115 mm)	
Blade angle, max.	C	± 25°	
Blade rotate, max.	F	± 8°	
Blade tilt (adjustable)*		52° - 58°	
Blade digging depth	G	15.9' (405 mm)	
Blade clearance	H	11' (280 mm)	
Ripper penetration, max.*	I	73.2' (1860 mm)	
Ripper beam width	J	68.5' (1740 mm)	
Ripper, cut width	K	34.3' (870 mm)	
Ripper, shank distance	L	21.4' (544 mm)	
Ripper departure angle, raised*	M	-	
Operating weight (without ripper)		30865 lb. (14009 kg)	31747 lb. (14446 kg)
Ground pressure		6.0 psi (41.5 kPa)	4.7 psi (32.3 kPa)

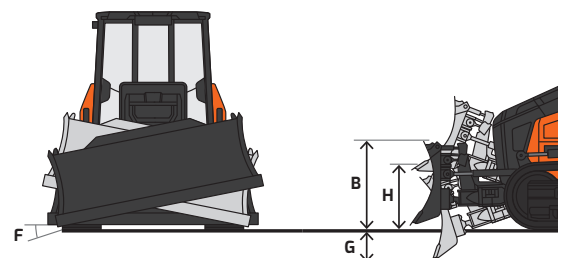
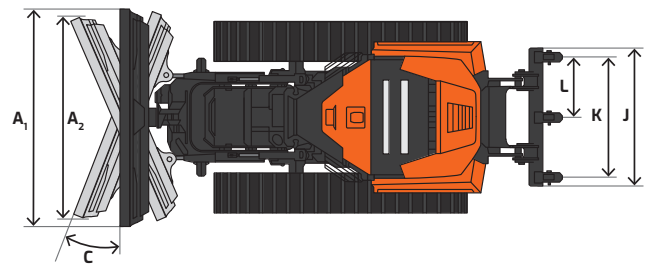

*Not shown on diagram

Standard & Optional Equipment

| Standard Base Package, US20

■ Standard ● Optional

Engine

Emissions, T4 (EPA)	■
Direct fuel injected	■
Fuel filter with water separator	■
Coolant recovery tank	■
Dual element dry-type air filter	■
Electronic engine control	■
Auto idle	■
Overheat & low oil pressure engine protection	■

Hydraulic

Variable axial piston main pump	■
Full electric hydraulics	■
Hydraulic transmission	■
Adjustable auxiliary flow	■

Electrical

Alternator – 12 V, 90 amp	■
12 V battery, 725 CCA @ 0° F (-18° C)	■
Additional LED lighting	●
Rotating beacon	●
Hour meter	■
Laptop service port	■
Self-diagnostics system	■

Cabin

Steel, all-weather & sound suppressed	■
ROPS/TOPS (ISO 12117-2:2008)	■
Front window and side window with wiper/washer	■
Rearview camera	■
8 inch touch display	■
Rear window defrost in-glass	■
Tinted safety glass	■
Lockable doors	■
Seat	■
- 2" (51 mm) seat belt	■
- Adjustable height & recline, air suspension	■
Adjustable armrests	■
Air conditioner with heater	■
Mirrors	■
AM/FM stereo & Bluetooth®	■
Speakers (2)	■
Power socket, 12 V	■
Interior light	■
Storage for operator's manuals	■

Controls

Blade Shake	■
Blade Float	■
2D Grading	●
Eco Mode	■
Blade control lever	■
Dozer Assist Control System	■
Engine speed control dial	■
Switches, console-mounted	■
- Starter switch (key)	■
- Heater/AC control panel	■
- Boom swing switch	■
- Rotating beacon (if equipped)	■
- 12 V power socket & USB charger	■
Keypad buttons	■
- Overload warning	■
- Travel/swing alarm	■
- Light	■
- Work lights	■
- Wiper & washer	■
- Auto idle	■
Emergency stop switch	■

Display Monitor & Warnings

Buzzer	■
- Engine oil pressure	■
- Coolant temperature	■
Touch screen display monitor	■
- Digital clock	■
- Menu select button	■
- Back button	■
- Fuel gauge	■
- Engine coolant temperature	■
- Hydraulic oil temperature	■
- Mode	■
- Tachometer	■
- Operating mode/flow setting selector	■
Indicator lights	■
- Air filter restriction indicator	■
- Engine check warning light	■
- Hydraulic oil warning	■
- Fuel warning	■
- Auto idle indicator	■
- Auxiliary flow mode indicator	■
- Engine oil pressure light with audible alarm	■
- Preheat (cold start assist) indicator	■
- Two-speed travel indicator light	■
Travel alarm	■

Undercarriage

Idler trap strings	■
Double and single sided rollers	■
Oscillating undercarriage	■
Full track guard	●
Adjustable/replaceable idler guide plate	■
Serrated tracks	■
Shoes, steel grouser	■

Other

Centralized lubrication	■
Parallel ripper	●
Cab-raise	■
Reversible cutting edge	■
Forestry guard	●
Dozer blade	■
Manuals	■
- Operation	■
- AEM safety manual	■
Vandalism protection	■
- Lockable panels	■
- Lockable fluid fill points	■
DEVELON Fleet Management	■

Certain specification(s) are based on engineering calculations and are not actual measurements. Specification(s) are provided for comparison purposes only and are subject to change without notice. Specification(s) for your individual DEVELON equipment will vary based on normal variations in design, manufacturing, operating conditions, and other factors. Pictures of DEVELON units may show other than standard equipment.

Powered by Innovation

DEVELON

A brand of HD Hyundai Infracore.

na.develon-ce.com/dd130

DD130 Dozer Spec Sheet
Printed in the U.S.A.
23914_002_D090623

©2023 HD Hyundai Infracore. All rights reserved.