

DEVELON

Crawler Excavator

DX200LC-7



Engine

Make	Perkins
Model	1204J
Number of cylinders	4
Rated power, gross (hp per SAE J1995)	147.5 hp (110 kW) @ 2000 rpm
Rated power, net (hp per SAE J1349)	138.1 hp (103 kW) @ 2000 rpm
Max. torque, net (SAE J1995)	413 lb.-ft. (560 Nm) @ 1400 rpm
Displacement	269 in. ³ (4.4 L)
Bore and stroke	4.1 in. x 5.0 in. (105 mm x 127 mm)
Starter	24 V, 8.6 hp (6.0 kW)
Battery	2 x 12 V, 100 AH
Alternator	24 V, 85 amp
Air cleaner	Two-stage

Hydraulics

Main pumps	2 x 56 gpm (2 x 212 L/min.)
Pilot pump (gear design)	8 gpm (30 L/min.)

Working Pressure

Boom/arm/bucket (normal mode)	4978 psi (350 kg/cm ²)
Boom/arm/bucket (power boost)	5263 psi (370 kg/cm ²)
Travel	5263 psi (370 kg/cm ²)
Swing	3980 psi (280 kg/cm ²)
Pilot	566 psi (40 kg/cm ²)

Undercarriage

Upper rollers (each track)	2
Lower rollers (each track)	8
Number of shoes (links per side)	49

Swing Mechanism

Swing speed	0 – 11 rpm
Swing torque	63000 lbf.-ft. (8710 kgf-m)

Drive System

Travel speed (low – high)	1.86 – 3.48 mph (3.0 – 5.6 km/h)
Traction force, max. (drawbar pull)	60715 lbf. (27540 kgf)
Max. grade (limited by engine lub)	70% (35°)

Environment

Sound level (2000/14/EC)	102 dB(A)
Cabin sound level (ISO 6396)	70 dB(A)

Refill Capacities

Fuel tank	101 gal. (384 L)
DEF tank	4 gal. (15 L)
Cooling system (radiator capacity)	7.1 gal. (27.1 L)
Engine oil (with filler)	3.9 gal. (15 L)
Swing drive	1.3 gal. (5 L)
Final drive (each side)	1.1 gal. (4 L)
Hydraulic system	51.7 gal. (196 L)
Hydraulic tank	31.9 gal. (121 L)

Hydraulic Cylinders

Boom ¹ (2) bore x rod diameter x stroke	4.9 in. x 3.4 in. x 49.7 in. (125 mm x 85 mm x 1263 mm)
Arm ^{1,2} (1) bore x rod diameter x stroke	5.3 in. x 3.9 in. x 56.8 in. (135 mm x 100 mm x 1443 mm)
Bucket (STD) ¹ (1) bore x rod diameter x stroke	4.7 in. x 3.1 in. x 41.7 in. (120 mm x 80 mm x 1060 mm)

¹ Cushion on rod end

² Cushion on base end

The piston rods and cylinder bodies are made of high-strength steel. A shock-absorbing mechanism is fitted in all cylinders to ensure shock-free operation and extended piston life.

Dimensions

Standard Arm
31.5" (800 mm) TG Shoe
(US20)

Boom length		18' 8" (5700 mm)
Arm length		7' 10" (2400 mm)
Bucket type (SAE)		1.20 yd ³ (0.92 m ³)
Track type		Fixed
Tail swing radius	A ₁	9' 7" (2909 mm)
Tail swing overhang (rear)	A ₂	2' 3" (686 mm)
Tail swing overhang (side)	A ₃	4' 8" (1414 mm)
Shipping height (boom)*	B	9' 8" (2940 mm)
Shipping height (hose)*	C	10' 2" (3105 mm)
Shipping length	D	31' 5" (9600 mm)
Shipping width	E	10' 5" (3190 mm)
Counterweight clearance*	F	3' 7" (1092 mm)
Cabin height*	G	9' 9" (2980 mm)
Upper structure width	H	8' 11" (2710 mm)
Cabin height above house*	I	2' 9" (840 mm)
Cabin width	J	3' 4" (1010 mm)
Tumbler distance	K	12' 0" (3650 mm)
Overall track length	L	14' 7" (4445 mm)
Undercarriage width	M	10' 6" (3190 mm)
Track gauge	N	7' 10" (2390 mm)
Track shoe width	O	31.5" (800 mm)
Track height*	P	3' 1" (945 mm)
Car body clearance*	Q	1' 5" (450 mm)

*Without shoe grouser

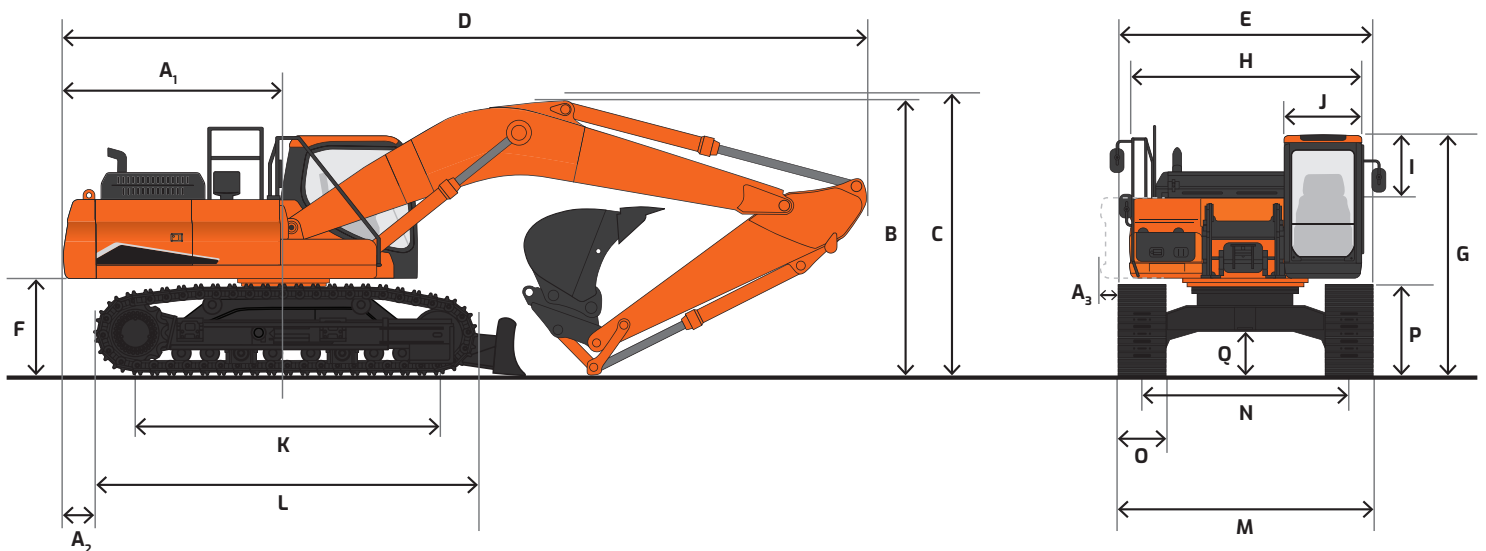

Working Range

Standard Arm
31.5" (800 mm) TG Shoe
(US20)

Boom length		18' 8" (5700 mm)
Arm length		7' 10" (2400 mm)
Bucket type (SAE, PCSA)		1.37 yd ³ (1.05 m ³)
Track type		Fixed
Max. digging reach	A	31' 0.5" (9460 mm)
Max. digging reach (ground)	B	30' 5" (9280 mm)
Max. digging depth	C	20' 0" (6105 mm)
Max. loading height	D	21' 10" (6675 mm)
Min. loading height	E	9' 10" (2985 mm)
Max. digging height	F	30' 11" (9425 mm)
Max. bucket pin height	G	26' 8" (8130 mm)
Max. vertical wall depth	H	17' 8" (5385 mm)
Max. radius vertical	I	19' 9" (6025 mm)
Max. depth to 8' line	J	19' 4" (5890 mm)
Min. radius to 8' line	K	9' 4" (2840 mm)
Min. digging reach	L	5' 7" (1690 mm)
Min. swing radius	M	11' 9" (3575)
Bucket angle (DEG)	d	177°
Digging force, bucket (PCSA)	ISO	36376 lbf. (16500 kgf)
Digging force, arm		29542 lbf. (13400 kgf)
Operating weight		51147 lb. (23200 kg)
Ground pressure		5.3 psi (0.37 kg/cm ²)

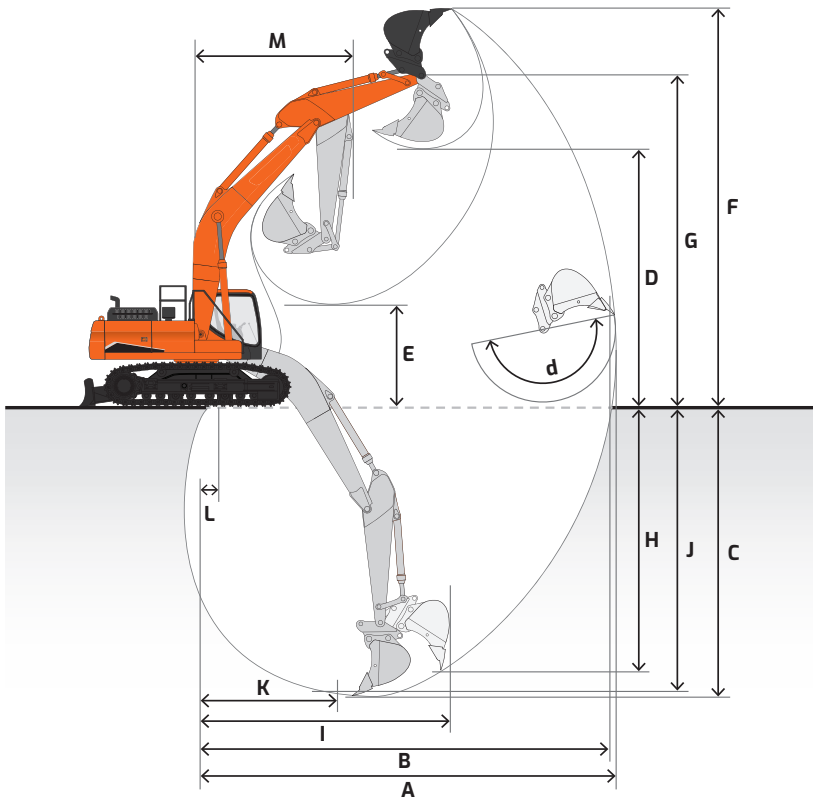

Bucket

Standard Arm (US20)

Boom	18' 8" (5700 mm)	
Arm	7' 10" (2400 mm)	
Shoe size	31.5" (800 mm)	
Track type	Fixed	
Mount	Pin-on	Quick-coupler
Counterweight	9460 lb. (4300 kg)	

Bucket Type	Model	Capacity* yd ³ (m ³)	Width in. (mm)	Weight lb. (kg)		
Heavy-duty	HD22-024	0.55 (0.42)	24 (610)	1394 (632)	A	A
	HD22-030	0.74 (0.57)	30 (762)	1566 (710)	A	A
	HD22-036	0.94 (0.72)	36 (914)	1747 (792)	A	A
	HD22-042	1.14 (0.87)	42 (1067)	1893 (858)	A	A
	HD22-048	1.34 (1.02)	48 (1219)	2074 (940)	A	B
Severe-duty	SD14-024	0.55 (0.42)	24 (610)	1424 (645)	A	A
	SD14-030	0.74 (0.57)	30 (762)	1586 (719)	A	A
	SD14-036	0.94 (0.72)	36 (914)	1774 (804)	A	A
	SD14-042	1.14 (0.87)	42 (1067)	1919 (870)	A	A
	SD14-048	1.34 (1.02)	48 (1219)	2097 (951)	A	B
Ditching	DC200-048	0.97 (0.74)	48 (1219)	1195 (542)	A	A
	DC200-060	1.22 (0.93)	60 (1524)	1395 (632)	A	A
	DC200-072	1.34 (1.02)	72 (1829)	1565 (709)	A	A
	HDC200-060	1.96 (1.50)	60 (1524)	2370 (1075)	C	C
	HDC200-066	2.16 (1.65)	66 (1676)	2554 (1158)	C	X

*Capacity based on ISO 7451 and heaped with a 1:1 angle of repose

- Equipped with bolt-on wear shrouds
- Equipped with bolt-on teeth
- Equipped with bolt-on cutting edge
- These recommendations are given as a guide only and based on typical operating conditions.

Maximum Suitable Material Density

- A 3370 lb./yd³ (2000 kg/m³)
- B 2700 lb./yd³ (1600 kg/m³)
- C 1850 lb./yd³ (1100 kg/m³)
- X Not Approved













Please consult with your DEVELON dealer to properly match buckets and attachments for the application.

Lifting Capacity

 Rating over front  Rating over side or 360°

DX200LC-7 US20

Boom: 18' 8" (5700 mm) | Arm: 7' 10" (2400 mm) | Counterweight: 9480 lb. (4300 kg) | 31.5" (800 mm) TG Shoes | Bucket: None | Unit: lb. (kg)

A (ft. or m) B (ft. or m)	5' (1.5 m)		10' (3.0 m)		15' (4.5 m)		20' (6.0 m)		25' (7.5 m)		Max. Reach		
													A
25' (7.5 m)											* 12420 (* 5645)	* 12420 (* 5645)	18.4' (5.61 m)
20' (6.0 m)							* 11870 (* 5395)	* 11870 (* 5395)			* 11400 (* 5182)	10720 (4873)	22.38' (6.82 m)
15' (4.5 m)					* 15190 (* 6905)	* 15190 (* 6905)	* 12760 (* 5800)	* 12760 (* 5800)	* 11780 (* 5355)	9130 (4150)	* 11130 (* 5059)	9040 (4109)	24.75' (7.54 m)
10' (3.0 m)					* 18700 (* 9768)	18650 (8477)	* 14260 (* 6482)	12370 (5623)	* 12210 (* 5550)	8960 (4073)	* 11370 (* 5168)	8250 (3750)	25.99' (7.92 m)
5' (1.5 m)					* 21490 (* 9768)	17660 (8027)	* 15690 (* 7132)	11890 (5405)	* 12780 (* 5890)	8750 (3977)	* 12100 (* 5500)	7990 (3632)	26.25' (8.00 m)
Ground Level					* 22360 (* 10163)	17230 (7832)	* 16430 (* 7468)	11580 (5264)	* 12960 (* 5891)	8610 (3914)	* 12360 (* 5618)	8190 (3723)	25.56' (7.79 m)
-5' (-1.5 m)		* 21340 (* 9700)	* 21340 (* 9700)		* 21540 (* 9791)	17190 (7814)	* 16080 (* 7309)	11500 (5227)			* 12590 (* 5723)	8990 (4.860)	23.84' (7.27 m)
-10' (-3.0 m)		* 25400 (* 11545)	* 25400 (* 11545)		* 18940 (* 8609)	17440 (7927)	* 13880 (* 6273)	11700 (5318)			* 12550 (* 5705)	10900 (3340)	20.84' (6.35 m)
-15' (-4.5 m)					* 12740 (* 5790)	* 12740 (* 5790)					* 11310 (* 5141)	* 11310 (* 5141)	15.82' (4.82 m)

A Distance from center of rotation
B Height

NOTE: Lifting capacities are in compliance with SAE 1097 and ISO 10567. Machine in lifting mode with power boost turned on. Load point is the end of the arm. Rated loads shown do not exceed 75% of minimum tipping loads or 87% of hydraulic capacities. Rated loads marked with an asterisk (*) are limited by hydraulic capacities. The least stable position is over the side. The total mass of machine includes the mass of the boom, arm, counterweight, all operating fluids and 165 lb. (75 kg) operator.

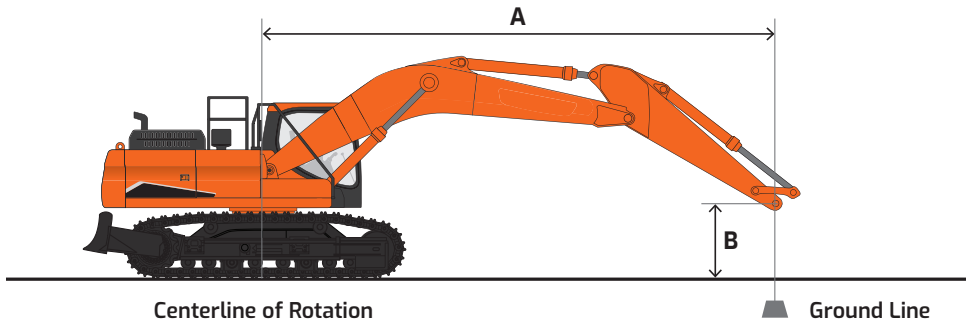

Standard & Optional Equipment

■ Standard ● Optional

Engine

Emissions (EPA)	T4f
High-pressure common-rail (HPCR)	■
Turbo, waste gate (WGT)	■
Cooled exhaust gas recirculation (CEGR)	■
Diesel oxidation catalyst (DOC)	■
Diesel particulate filter (DPF)	■
Selective catalyst reduction (SCR)	■
Diesel exhaust fluid (DEF)	■
Fuel filter with water separator	■
Coolant expansion tank	■
Dual element dry-type air filter with evacuator	■
Precleaner	■
Electronic engine control (ECU)	■
Auto idle	■
Auto shutdown (time-adjustable)	■
Overheat & low oil pressure engine protection	■
Block heater (110 V)	●
Water separator with heater	●
Fuel filler pump	●

Hydraulic

Electronic Power Optimizing System (EPOS)	■
Variable axial piston main pump (tandem)	■
Cross-sensing pump control	■
Pilot-operated control valves	■
Gear pilot pump	■
Smart Power Control (SPC)	■
Variable-speed hydraulic cooling fan	■
Axial piston swing motor	■
Spring-applied hydraulic release brake, swing motor	■
Axial piston travel motor (high/low, auto)	■
Auxiliary hydraulics, one- & two-way piping	■
Auxiliary hydraulics, tilt/rotate piping	●
Adjustable auxiliary flow & pressure, 10 presets	■
Intelligent floating boom	●
Breaker filter	●
Boom & arm lock valves	●
Clamshell piping	●
Straight travel	●

Controls

Joystick controls	■
Pattern control change valve (SAE, ISO)	■
Joystick attachment control	■
Switches/buttons	■
- Right (one-way, two-way, power boost)	■
- Left (tilt/rotate, horn, one-touch decel)	■
Foot pedal attachment control	■
Control stands	■
- Height adjustable	■
- Sliding (fore/aft)	■
- Tilting armrests	■
Engine speed control dial	■
Travel pedals with hand levers	■
Straight travel pedal	●
Switches, console-mounted	■
- Starter button switch	■
- Travel speed selector	■
- Work light	■
- Auxiliary mode switch	■
Emergency stop switch	■
Power modes (P+, P, S, E)	■
Work modes (digging, lifting, breaker, shear)	■
Smart Power Control (SPC)	■
Jog dial display control	■
Wiper control panel	■
Audio control panel	■

Cabin

Steel, all-weather & sound-suppressed	■
ROPS (ISO 12117-2:2008)	■
Viscous mount with spring reinforcement	■
Front window with wiper/washer	■
Tinted safety glass	■
Skylight top hatch with sun screen	■
Front window with sun screen	■
Pull-up type top front window	■
Removable lower front window with storage behind seat	■
Adjustable sliding side door window	■
Defrost, front window	■
Lockable doors	■
Seat	■
- Heated	■
- Air suspension	■
- 2" (51 mm) seat belt	■
- Adjustable height & recline	■
- Adjustable fore/aft	■
- Adjustable armrests	■
Leatherette seat	■
- Heating & cooling	■
- Air suspension	■
- 2" (51 mm) seat belt	●
- Adjustable height & recline	●
- Adjustable fore/aft	●
- Adjustable armrests	●
3" (76 mm) seat belt	●
Control stands	■
- Height adjustable	■
- Mounted to seat base	■
Storage for operator's manuals	■
Mirrors	■
Fully automatic HVAC with ambient temperature sensor	■
8" multi-function LCD interactive display monitor	■
Cigarette lighter	■
Digital audio broadcasting stereo	■
Speakers (2)	■
Antenna, roof-mounted	■
Emergency breakout tool	■
Hot/cold beverage compartment	■
Power socket, 12 V & 24 V	■
Cup holder	■
Interior light	■
Coat hanger	■
Rain shield	●
Fog guard	●
Front window guard	●

Electrical

System voltage – 24 V	■
Alternator – 24 V, 85 amp	■
2 x 12 V batteries, 100 AH reserve capacity, 900 CCA	■
Blade-type fuse panel	■
Main circuit breaker	■
Light, work (LED): machine (2), boom (2)	■
Light, work (LED): 6 cab top, front (4), rear (2)	●
Light, work (LED): 4 cab top, front (2), rear (2)	●
Rotating beacon	●
Overload warning alarm	●
Hour meter	■
Engine restart prevention system	■
Side view & rearview camera with LED lamps (3)	■
360° all-around view camera	●
Microphone & speaker	●
Ultrasonic sensor	●
Laptop service port	■
Self-diagnostics system	■
Smart key (remote ignition key)	■
DEVELON Fleet Management	■

Display Monitor & Warnings

Indicators	■
- Work modes (P+, P, S, E)	■
- User/Service menu	■
Gauges	■
- Fuel level	■
- DEF level	■
- Engine coolant temperature	■
- Hydraulic oil temperature	■
- Engine rpm	■
- Battery voltage	■
- Hydraulic pump pressure	■
- ECO	■
- Digital clock	■
- Trip meter	■
- Hour meter	■
- Fuel consumption	■
Warning & indicator lights	■
- Seat belt	■
- Error code	■
- SCR warning	■
- DPF warning	■
- Check engine	■
- Engine oil pressure	■
- Engine pre-heat engaged	■
- Radiator coolant level & temperature	■
- Air filter	■
- Fuel level	■
- DEF level – low	■
- Water in fuel	■
- Battery charge	■
- Work lights on	■
- Hydraulic oil temperature	■
- Hydraulic charge pressure	■
- Hydraulic pilot filter	■
- Hydraulic return filter	■
Swing alarm	■
Travel alarm	■
Buzzer	■
- Engine oil pressure	■
- Coolant temperature	■

Undercarriage

Track guards & chains with adjusters	■
Track rollers, upper	2
Track rollers, lower	8
In-shoe motor protection	■
Shoes, triple grouser – 700 mm	●
Shoes, triple grouser – 800 mm	■
Shoes, triple grouser – 900 mm	●
Dozer blade, front	●

Other

Centralized lubrication	■
- Boom	■
- Swing	■
Handrails & service platforms	■
Skid-resistant steps & service platforms	■
Manuals	■
- Operation & Maintenance	■
- Parts	■
- AEM Safety Manual	■
DEVELON Fleet Management 3-year subscription	■
Vandalism protection	■
- Lockable panels	■
- Lockable fluid fill points	●
- Anti-theft protection (password)	●
- Vandalism window cover mount	●
Air compressor	●

Certain specification(s) are based on engineering calculations and are not actual measurements. Specification(s) are provided for comparison purposes only and are subject to change without notice. Specification(s) for your individual DEVELON equipment will vary based on normal variations in design, manufacturing, operating conditions, and other factors. Pictures of DEVELON units may show other than standard equipment.

Powered by Innovation

DEVELON

A brand of HD Hyundai Infracore.

na.develon-ce.com/dx200lc-7

DX200LC-7 Crawler Excavator Spec Sheet
Printed in the U.S.A.
23906_003_D082923

©2023 HD Hyundai Infracore. All rights reserved.