

DEVELON

Crawler Excavator

DX350LC-7



Engine

Make	DEVELON
Model	DL08-LEE04
Number of cylinders	6
Rated power, gross (hp per SAE J1995)	285.6 hp (213 kW) @ 1800 rpm
Rated power, net (hp per SAE J1349)	280.3 hp (209 kW) @ 1800 rpm
Max. torque, net (SAE J1995)	940 lbf.ft. (1275 Nm) @ 1300 rpm
Displacement	466 in. ³ (7.6 L)
Bore and stroke	4.3 in. x 5.5 in. (108 mm x 139 mm)
Starter	24 V, 8.0 hp (6.0 kW)
Battery	2 x 12 V, 150 AH, 1300 CCA
Alternator	24 V, 80 amp
Air cleaner	Three-stage

Hydraulics

Main pumps	2 x 92.4 gpm (2 x 350 L/min.)
Pilot pump (gear design)	6.3 gpm (24 L/min.)
Relief pressure (normal mode)	5077 psi (357 kg/cm ²)
Relief pressure (power boost)	5360 psi (377 kg/cm ²)

Working Pressure

Boom/arm/bucket (normal mode)	5080 psi (357 kg/cm ²)
Boom/arm/bucket (power boost)	5360 psi (377 kg/cm ²)
Travel	4980 psi (350 kg/cm ²)
Swing	4270 psi (300 kg/cm ²)

Undercarriage

Upper rollers (each track)	2
Lower rollers (each track)	9
Number of shoes (links per side)	48
Total length of track	16' 3" (4960 mm)

Swing Mechanism

Swing speed	0 - 9.3 rpm
Swing torque	107483 lbf.ft. (14860 kgf.m)

Drive System

Travel speed (low - high)	2.1 - 3.5 mph (3.4 - 5.6 km/h)
Traction force, max. (drawbar pull)	75800 lbf.ft. (34382 kgf.m)
Max. grade (limited by engine lub)	70% (35°)

Environment

Sound level (2000/14/EC)	105 dB(A)
Cabin sound level (ISO 6396)	71 dB(A)

Refill Capacities

Fuel tank	158.5 gal. (600 L)
DEF tank	16.4 gal. (62 L)
Cooling system (radiator capacity)	14.8 gal. (56 L)
Engine oil (with filler)	11.1 gal. (42 L)
Swing drive	2.1 gal. (8 L)
Final drive (each side)	1.8 gal. (7 L)
Hydraulic system	100.3 gal. (380 L)
Hydraulic tank	64.2 gal. (243 L)

Hydraulic Cylinders

Boom ¹ (2) bore x rod diameter x stroke	Mono boom	5.9 in. x 3.9 in. x 571 in. (150 mm x 100 mm x 1450 mm)
	2-PC boom (lower)	-
	2-PC boom (upper)	-
Arm ^{1,2} (1) bore x rod diameter x stroke		6.7 in. x 4.7 in. x 711 in. (170 mm x 120 mm x 1805 mm)
Bucket ¹ (1) bore x rod diameter x stroke	STD	5.9 in. x 3.9 in. x 51.2 in. (150 mm x 100 mm x 1300 mm)
	SLR	-

¹ Cushion on rod end

² Cushion on base end

The piston rods and cylinder bodies are made of high-strength steel. A shock-absorbing mechanism is fitted in all cylinders to ensure shock-free operation and extended piston life.

NOTE: Where applicable, dimensions are in accordance with Society of Automotive Engineers (SAE) and ISO standards. Specifications and design are subject to change without notice. All dimensions are given for DEVELON excavators equipped with standard tracks and the standard front as listed. Pictures of DEVELON excavators may show other than standard equipment. All dimensions are shown in inches. Respective metric dimensions are enclosed by parentheses. Rounding may impact specifications. DEVELON equipment is manufactured with a Quality Management System that is in compliance with ISO 9001:2008.

Dimensions

		Standard Arm 31.5" (800 mm) TG Shoe (U520)	Long Arm 33.5" (850 mm) TG Shoe (U530)
Boom length		21' 3" (6500 mm)	
Arm length		10' 6" (3200 mm)	13' 0" (3950 mm)
Bucket type (SAE)		1.95 yd ³ (1.49 m ³)	1.63 yd ³ (1.25 m ³)
Track type		Fixed	
Tail swing radius	A ₁	11' 7" (3530 mm)	
Tail swing overhang (rear)	A ₂	3' 5" (1050 mm)	
Tail swing overhang (side)	A ₃	6' 0" (1830 mm)	5' 9" (1765 mm)
Shipping height (boom)	B	10' 8" (3255 mm)	11' 3" (3420 mm)
Shipping height (hose)	C	11' 3" (3420 mm)	11' 8" (3550 mm)
Shipping length	D	37' 1" (11315 mm)	37' 3" (11345 mm)
Shipping width	E	11' 5" (3480 mm)	11' 7" (3530 mm)
Counterweight clearance*	F	3' 10" (1160 mm)	
Cabin height	G	10' 2" (3100 mm)	
Upper structure width	H	9' 10" (2990 mm)	
Cabin height above house	I	2' 10" (855 mm)	
Cabin width	J	3' 4" (1010 mm)	
Tumbler distance	K	13' 3" (4040 mm)	
Overall track length	L	16' 3" (4960 mm)	
Undercarriage width	M	11' 5" (3480 mm)	11' 7" (3530 mm)
Track gauge	N	8' 10" (2680 mm)	
Track shoe width	O	31.5" (800 mm)	33.5" (850 mm)
Track height*	P	3' 2" (970 mm)	
Car body clearance*	Q	1' 7" (475 mm)	

*Without shoe grouser height (30 mm)

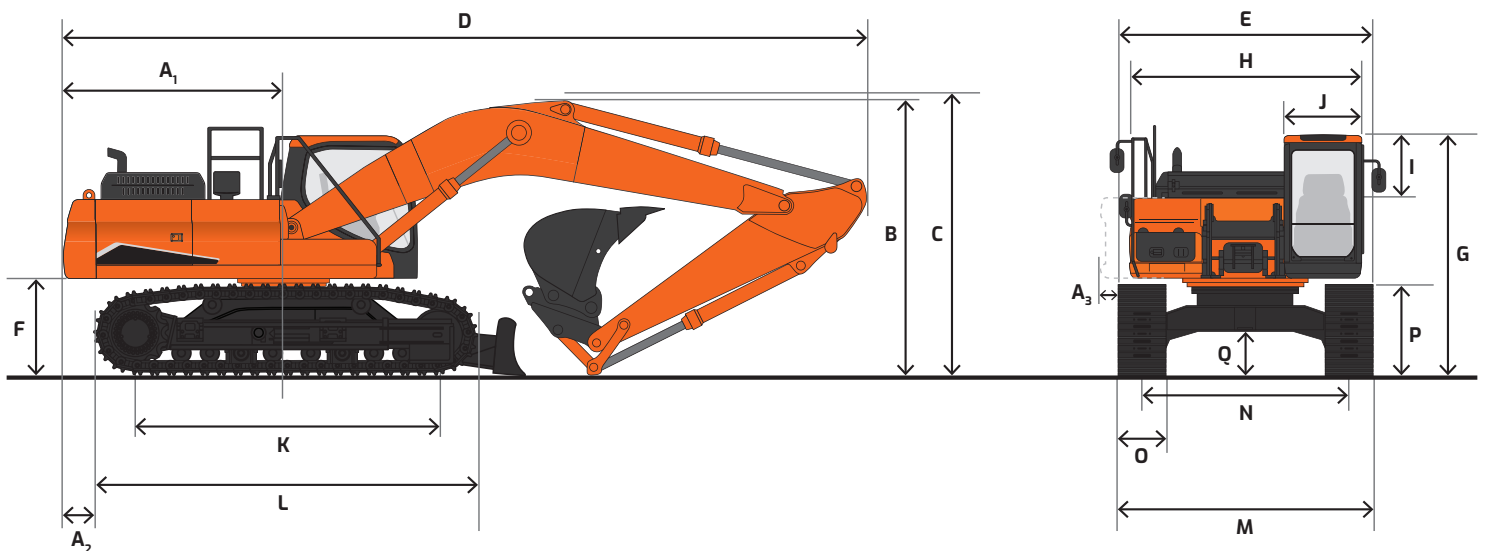

Working Range

		Standard Arm 31.5' (800 mm) TG Shoe (US20)	Long Arm 33.5' (850 mm) TG Shoe (US30)
Boom length		21' 4" (6500 mm)	
Arm length		10' 6" (3200 mm)	13' 0" (3950 mm)
Bucket type (SAE, PCSA)		1.95 yd ³ (1.49 m ³)	1.63 yd ³ (1.25 m ³)
Track type		Fixed	
Max. digging reach	A	36' 6" (11180 mm)	39' 2" (11930 mm)
Max. digging reach (ground)	B	36' 0" (10980 mm)	38' 6" (11740 mm)
Max. digging depth	C	24' 9" (7540 mm)	27' 2" (8290 mm)
Max. loading height	D	23' 6" (7175 mm)	25' 1" (7635 mm)
Min. loading height	E	8' 10" (2705 mm)	6' 10" (2080 mm)
Max. digging height	F	33' 10" (10315 mm)	35' 6" (10815 mm)
Max. bucket pin height	G	29' 1" (8875 mm)	30' 8" (9335 mm)
Max. vertical wall depth	H	19' 4" (5885 mm)	22' 5" (6830 mm)
Max. radius vertical	I	25' 4" (7720 mm)	25' 6" (7785 mm)
Max. depth to 8' line	J	24' 1" (7345 mm)	26' 9" (8155 mm)
Min. radius to 8' line	K	10' 11" (3315 mm)	11' 2" (3395 mm)
Min. digging reach	L	2' 4" (710 mm)	-1' 1" (-350 mm)
Min. swing radius	M	14' 7" (4455 mm)	14' 10" (4515 mm)
Bucket angle (DEG)	d	178.3°	
Digging force, bucket (PCSA)*		57100 lbf. (25900 kgf)	
Digging force, arm*	ISO	41665 lbf. (18900 kgf)	35275 lbf. (16000 kgf)
Operating weight		82894 lb. (37600 kg)	83633 lb. (38015 kg)
Ground pressure		7.7 psi (0.54 kg/cm ²)	7.3 psi (0.51 kg/cm ²)

*With power boost ON

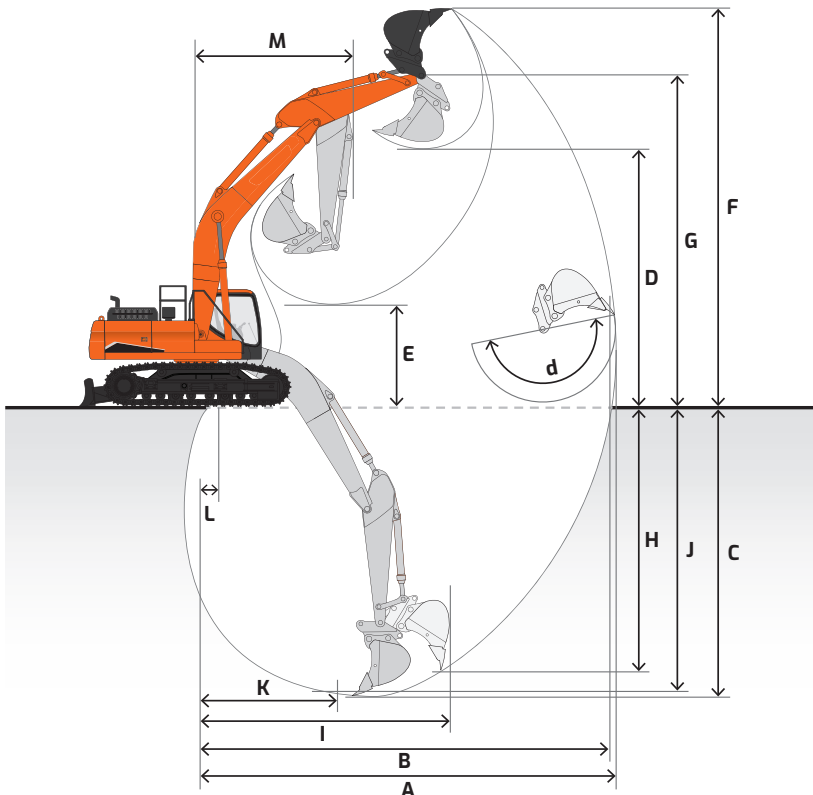















Lifting Capacity

 Rating over front  Rating over side or 360°

DX350LC-7 US20

Boom: 21' 3" (6500 mm) | Arm: 10' 6" (3200 mm) | Counterweight: 15653 lb. (7100 kg) | 31.5" (800 mm) Shoes | Bucket: None | Unit: lb. (kg)

A (ft. or m) B (ft. or m)	5' (1.5 m)		10' (3.0 m)		15' (4.5 m)		20' (6.0 m)		25' (7.5 m)		30' (9.0 m)		Max. Reach		
															A
25' (7.5 m)									* 17790 (* 8070)	* 17790 (* 8070)			* 17110 (* 7760)	* 17110 (* 7760)	25.36' (7.73 m)
20' (6.0 m)									* 18070 (* 8200)	17870 (8110)			* 16670 (* 7560)	14170 (6430)	28.22' (8.6 m)
15' (4.5 m)					* 27770 (* 12600)	* 27770 (* 12600)	* 22260 (* 10100)	* 22260 (* 10100)	* 19470 (* 8830)	17330 (7860)	* 18090 (* 8210)	12940 (5870)	* 16850 (* 7640)	12580 (5710)	30.01' (9.15 m)
10' (3.0 m)					* 35380 (* 16050)	35006 (15900)	* 25870 (* 11730)	23060 (10460)	* 21330 (* 9680)	16650 (7550)	18830 (8540)	12640 (5730)	17520 (7950)	11750 (5330)	30.91' (9.42 m)
5' (1.5 m)					* 40790 (* 18500)	32890 (14920)	* 29010 (* 13160)	21900 (9930)	* 23090 (* 10480)	16010 (7260)	18480 (8380)	12320 (5590)	17190 (7800)	11460 (5200)	30.99' (9.45 m)
Ground Level					* 42510 (* 19280)	32000 (14510)	* 30830 (* 13980)	21160 (9600)	* 23750 (10770)	15550 (7060)	18240 (8270)	12090 (5490)	17600 (7980)	11680 (5300)	30.28' (9.23 m)
-5' (-1.5 m)			* 33130 (* 15030)	* 33130 (* 15030)	* 41610 (* 18880)	31850 (14450)	* 31000 (* 14060)	20870 (9460)	23520 (10670)	15350 (6960)			18930 (8590)	12520 (5680)	28.7' (8.75 m)
-10' (-3.0 m)	* 39390 (* 17870)	* 39390 (* 17870)	* 51680 (* 23440)	* 51680 (* 23440)	* 38540 (* 17480)	32150 (14590)	* 29280 (* 13280)	20960 (9510)	* 22620 (* 10260)	15460 (7010)			* 20690 (* 9380)	14370 (6520)	26.08' (7.96 m)
-15' (-4.5 m)			* 43410 (* 19690)	* 43410 (* 19690)	* 32590 (* 14780)	* 32590 (* 14780)	* 24630 (* 11170)	21510 (9760)					* 20850 (* 9460)	18460 (8370)	22.08' (6.73 m)

A Distance from center of rotation
B Height

NOTE: Lifting capacities are in compliance with SAE 1097 and ISO 10567. Machine in lifting mode with power boost turned on. Load point is the end of the arm. Rated loads shown do not exceed 75% of minimum tipping loads or 87% of hydraulic capacities. Rated loads marked with an asterisk (*) are limited by hydraulic capacities. The least stable position is over the side. The total mass of machine includes the mass of the boom arm counterweight all operating fluids and 165 lb. (75 kg) operator.

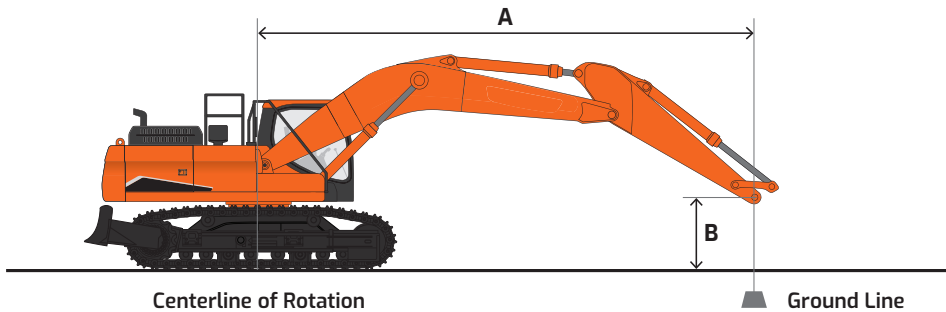















Lifting Capacity

 Rating over front  Rating over side or 360°

DX350LC-7 US30

Boom: 21' 3" (6500 mm) | Arm: 13' 0" (3950 mm) | Counterweight: 15653 lb. (7100 kg) | 33.5" (850 mm) Shoes | Bucket: None | Unit: lb. (kg)

A (ft. or m) B (ft. or m)	5' (1.5 m)		10' (3.0 m)		15' (4.5 m)		20' (6.0 m)		25' (7.5 m)		30' (9.0 m)		Max. Reach		
															A
30' (9.0 m)													* 14220 (* 6450)	* 14220 (* 6450)	24.24' (7.54 m)
25' (7.5 m)													* 12480 (* 5660)	* 12480 (* 5660)	28.36' (8.71 m)
20' (6.0 m)									* 16050 (* 7280)	* 16050 (* 7280)	* 15850 (* 7190)	13400 (6080)	* 12130 (* 5500)	* 12130 (* 5500)	30.94' (9.48 m)
15' (4.5 m)									* 17640 (* 8000)	* 17640 (* 8000)	* 16480 (* 7470)	13140 (5960)	* 12170 (* 5520)	11060 (5020)	32.59' (9.98 m)
10' (3.0 m)					* 31170 (* 14140)	* 31170 (* 14140)	* 23520 (* 10670)	* 23520 (* 10670)	* 19710 (* 8940)	16870 (7650)	* 17540 (* 7950)	12730 (5780)	* 12550 (* 5690)	10390 (4710)	33.41' (10.23 m)
5' (1.5 m)					* 37850 (* 17170)	33600 (15240)	* 27150 (* 12320)	22190 (10060)	* 21780 (* 9880)	16110 (7310)	18530 (8410)	12310 (5590)	* 13310 (* 6040)	10140 (4600)	33.49' (10.26 m)
Ground Level			* 20360 (* 9230)	* 20360 (* 9230)	* 41360 (* 18760)	32100 (14560)	* 29690 (* 13470)	21200 (9620)	* 23360 (* 10600)	15510 (7040)	18160 (8240)	11980 (5430)	* 14550 (* 6600)	10280 (4660)	32.83' (10.06 m)
-5' (-1.5 m)	* 21490 (* 9750)	* 21490 (* 9750)	* 30520 (* 13840)	* 30520 (* 13840)	* 41940 (* 19020)	31550 (14310)	* 30710 (* 13930)	20690 (9380)	23380 (10610)	15160 (6880)	17980 (8150)	11800 (5350)	16530 (7500)	10880 (4940)	31.38' (9.62 m)
-10' (-3.0 m)	* 32550 (* 14760)	* 32550 (* 14760)	* 43540 (* 19750)	* 43540 (* 19750)	* 40170 (* 18220)	31600 (14330)	* 30010 (* 13610)	20590 (9340)	23310 (10570)	15100 (6850)			18500 (8390)	12160 (5520)	29.03' (8.9 m)
-15' (-4.5 m)	* 45770 (* 20760)	* 45770 (* 20760)	* 50050 (* 22700)	* 50050 (* 22700)	* 35860 (* 16260)	32130 (14580)	* 27070 (* 12280)	20900 (9480)	* 20370 (* 9240)	15430 (7000)			19070 (8650)	14760 (6700)	25.5' (7.84 m)
-20' (-6.0 m)			* 37310 (* 16920)	* 37310 (* 16920)	* 27470 (* 12460)	* 27470 (* 12460)	* 19610 (* 8890)	* 19610 (* 8890)					* 18680 (* 8470)	* 18680 (* 8470)	20.21' (6.23 m)

A Distance from center of rotation
B Height

NOTE: Lifting capacities are in compliance with SAE 1097 and ISO 10567. Machine in lifting mode with power boost turned on. Load point is the end of the arm. Rated loads shown do not exceed 75% of minimum tipping loads or 87% of hydraulic capacities. Rated loads marked with an asterisk (*) are limited by hydraulic capacities. The least stable position is over the side. The total mass of machine includes the mass of the boom, arm, counterweight, all operating fluids and 165 lb. (75 kg) operator.

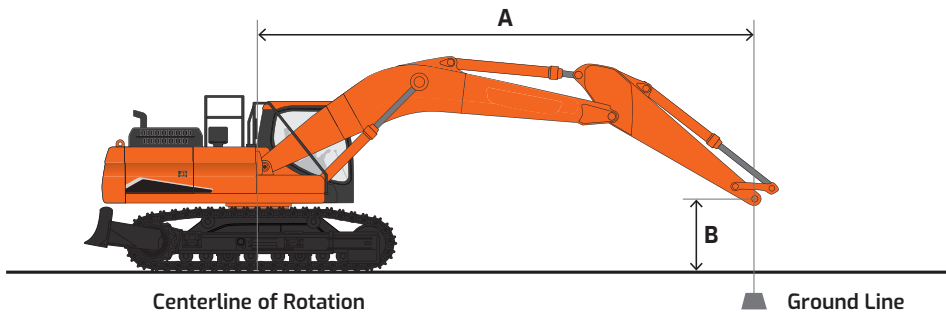

Standard & Optional Equipment

■ Standard ● Optional

Engine

Emissions (EPA)	T4f
High-pressure common-rail (HPCR)	■
Variable geometry (VGT)	■
Cooled exhaust gas recirculation (CEGR)	■
Selective catalyst reduction (SCR)	■
Diesel exhaust fluid (DEF)	■
Fuel filter with water separator	■
Coolant expansion tank	■
Dual element dry-type air filter with evacuator	■
Precleaner	■
Electronic engine control (ECU)	■
Auto idle	■
Auto shutdown (time-adjustable)	■
Overheat & low oil pressure engine protection	■
Block heater (110 V)	●
Fuel filler pump	●

Hydraulic

Electronic Power Optimizing System (EPOS)	■
Variable axial piston main pump (tandem)	■
Cross-sensing pump control	■
Pilot-operated control valves	■
Gear pilot pump	■
D-ECOPOWER	■
Smart Power Control (SPC)	■
Axial piston swing motor	■
Spring-applied hydraulic release brake, swing motor	■
Axial piston travel motor (high/low, auto)	■
Auxiliary hydraulics, one- & two-way piping	●
Auxiliary hydraulics, tilt/rotate piping	■
Adjustable auxiliary flow & pressure, 10 presets	■
Intelligent floating boom	●
Breaker filter	●
Boom & arm lock valves	●
Straight travel	●

Controls

Joystick controls	■
Pattern control change valve (SAE, ISO)	■
Joystick attachment control	■
Switches/buttons	■
- Right (one-way, two-way, power boost)	■
- Left (tilt/rotate, horn, one-touch decel)	■
Foot pedal attachment control	■
Control stands	■
- Height adjustable	■
- Sliding (fore/aft)	■
- Tilting armrests	■
Engine speed control dial	■
Travel pedals with hand levers	■
Straight travel pedal	●
Switches, console-mounted	■
- Starter button switch	■
- Travel speed selector	■
- Work light	■
- Auxiliary mode switch	■
Emergency stop switch	■
Power modes (P+, P, S, E)	■
Work modes (digging, lifting, breaker, shear)	■
Smart Power Control (SPC)	■
Jog dial display control	■
Bluetooth® control panel	■
Wiper control panel	■
Audio control panel	■

Cabin

Steel, all-weather & sound-suppressed	■
ROPS (ISO 12117-2:2008)	■
Viscous mount with spring reinforcement	■
Front window with wiper/washer	■
Tinted safety glass	■
Skylight top hatch with sun screen	■
Front window with sun screen	■
Pull-up type top front window	■
Removable lower front window with storage behind seat	■
Adjustable sliding side door window	■
Defrost, front window	■
Lockable doors	■
Seat	■
- Heated	■
- Air suspension	■
- 2" (51 mm) seat belt	■
- Adjustable height & recline	■
- Adjustable fore/aft	■
- Adjustable armrests	■
Leatherette seat	■
- Heating & cooling	■
- Air suspension	■
- 2" (51 mm) seat belt	●
- Adjustable height & recline	■
- Adjustable fore/aft	■
- Adjustable armrests	■
3" (76 mm) seat belt	●
Control stands	■
- Height adjustable	■
- Mounted to seat base	■
Storage for operator's manuals	■
Mirrors	■
Fully automatic HVAC with ambient temperature sensor	■
8" multi-function LCD interactive display monitor	■
Cigarette lighter	■
Digital Bluetooth audio broadcasting MP3 radio with cell phone integration	■
Speakers (2)	■
Antenna, roof-mounted	■
Emergency breakout tool	■
Hot/cold beverage compartment	■
Power socket, 12 V & 24 V	■
Cup holder	■
Interior light	■
Coat hanger	■
Rain shield	●
Fog guard	●
Panto wiper, front windshield & lower window	■
Front window guard	●
Vandalism window cover mount	■

Electrical

System voltage – 24 V	■
Alternator – 24 V, 100 amp	■
2 x 12 V batteries, 200 AH reserve capacity	■
Blade-type fuse panel	■
Main circuit breaker	■
Light, work (LED): machine (2), boom (2)	■
Light, work (LED): 6 cab top, front (4), rear (2)	●
Light, work (LED): 4 cab top, front (2), rear (2)	●
Rotating beacon	●
Hour meter	■
Engine restart prevention system	■
Side view & rearview camera with LED lamps (6)	■
360° all-around view camera	●
Ultrasonic sensor	●
Laptop service port	■
Self-diagnostics system	■
Smart key (remote ignition key)	■
DEVELON Fleet Management	■

Display Monitor & Warnings

Indicators	■
- Work modes (P+, P, S, E)	■
- User/Service menu	■
Gauges	■
- Fuel level	■
- DEF level	■
- Engine coolant temperature	■
- Hydraulic oil temperature	■
- Engine rpm	■
- Battery voltage	■
- Hydraulic pump pressure	■
- ECO	■
- Digital clock	■
- Trip meter	■
- Hour meter	■
- Fuel consumption	■
Warning & indicator lights	■
- Seat belt	■
- Error code	■
- SCR warning	■
- Check engine	■
- Engine oil pressure	■
- Engine pre-heat engaged	■
- Radiator coolant level & temperature	■
- Air filter	■
- Fuel level	■
- DEF level – low	■
- Water in fuel	■
- Battery charge	■
- Work lights on	■
- Hydraulic oil temperature	■
- Hydraulic charge pressure	■
- Hydraulic pilot filter	■
- Hydraulic return filter	■
Swing alarm	■
Travel alarm	■
Buzzer	■
- Engine oil pressure	■
- Coolant temperature	■

Undercarriage

Fixed track width	■
Track guards & chains with adjusters	■
Track rollers, upper	2
Track rollers, lower	9
In-shoe motor protection	■
Shoes, triple grouser – 700 mm	●
Shoes, triple grouser – 800 mm	■
Shoes, triple grouser – 900 mm	●

Frame

Counterweight, fixed	■
----------------------	---

Other

Centralized lubrication	■
- Boom	■
- Arm	■
- Swing	■
Handrails & service platforms	■
Skid-resistant steps & service platforms	■
Manuals	■
- Operation & Maintenance	■
- Parts	■
- AEM Safety Manual	■
DEVELON Fleet Management 3-year subscription	■
Vandalism protection	■
- Lockable panels	■
- Lockable fluid fill points	■
- Anti-theft protection (password)	■
- Vandalism window cover mount	■
Air compressor	●

Certain specification(s) are based on engineering calculations and are not actual measurements. Specification(s) are provided for comparison purposes only and are subject to change without notice. Specification(s) for your individual DEVELON equipment will vary based on normal variations in design, manufacturing, operating conditions, and other factors. Pictures of DEVELON units may show other than standard equipment.

Powered by Innovation

DEVELON

A brand of HD Hyundai Infracore.

na.develon-ce.com/dx350lc-7

DX350LC-7 Crawler Excavator Spec Sheet
Printed in the U.S.A.
23906_001_D062123

©2023 HD Hyundai Infracore. All rights reserved.