

# DEVELON

## Crawler Excavator

# DX255LC-7



### Engine

Make	DEVELON
Model	DL06P
Number of cylinders	6
Rated power, gross (hp per SAE J1995)	189 hp (141 kW) @ 1900 rpm
Rated power, net (hp per SAE J1349)	185.1 hp (138 kW) @ 1900 rpm
Max. torque, net (SAE J1995)	593 lb.-ft. (804 Nm) @ 1400 rpm
Displacement	359 in. <sup>3</sup> (5.9 L)
Bore and stroke	3.9 in. x 4.9 in. (100 mm x 125 mm)
Starter	24 V, 8.6 hp (6.0 kW)
Battery	2 x 12 V, 150 AH
Alternator	24 V, 100 amp
Air cleaner	Three-stage

### Hydraulics

Main pumps	2 x 57.9 gpm (2 x 219 L/min.)
Pilot pump (gear design)	7.5 gpm (28.5 L/min.)

### Working Pressure

Boom/arm/bucket (normal mode)	4978 psi (350 kg/cm <sup>2</sup> )
Boom/arm/bucket (power boost)	5263 psi (370 kg/cm <sup>2</sup> )
Travel	5263 psi (370 kg/cm <sup>2</sup> )
Swing	3916 psi (275 kg/cm <sup>2</sup> )
Pilot	566 psi (40 kg/cm <sup>2</sup> )

### Undercarriage

Upper rollers (each track)	2
Lower rollers (each track)	10
Number of shoes (links per side)	51

### Swing Mechanism

Swing speed	0 – 10.01 rpm
Swing torque	71462 lbf.-ft. (9880 kgf-m)

### Drive System

Travel speed (low – high)	1.99 – 3.48 mph (3.2 – 5.6 km/h)
Traction force, max. (drawbar pull)	57000 lbf.-ft. (25854 kgf-m)
Max. grade (limited by engine lub)	70% (35°)

### Environment

Sound level (2000/14/EC)	103 dB(A)
Cabin sound level (ISO 6396)	70 dB(A)

### Refill Capacities

Fuel tank	111 gal. (420 L)
DEF tank	8.3 gal. (31.5 L)
Cooling system (radiator capacity)	9.4 gal. (35.7 L)
Engine oil (with filler)	7.1 gal. (27 L)
Swing drive	1.9 gal. (7 L)
Final drive (each side)	1.9 gal. (7 L)
Hydraulic system	74 gal. (280 L)
Hydraulic tank	66 gal. (250 L)

### Hydraulic Cylinders

Boom <sup>1</sup> (2) bore x rod diameter x stroke	5.1 in. x 3.5 in. x 53.7 in. (130 mm x 90 mm x 1365 mm)
Arm <sup>1,2</sup> (1) bore x rod diameter x stroke	5.5 in. x 3.9 in. x 65.2 in. (140 mm x 100 mm x 1655 mm)
Bucket (STD) <sup>1</sup> (1) bore x rod diameter x stroke	4.9 in. x 3.4 in. x 42.5 in. (125 mm x 85 mm x 1080 mm)

<sup>1</sup> Cushion on rod end

<sup>2</sup> Cushion on base end

The piston rods and cylinder bodies are made of high-strength steel. A shock-absorbing mechanism is fitted in all cylinders to ensure shock-free operation and extended piston life.

NOTE: Where applicable, dimensions are in accordance with Society of Automotive Engineers (SAE) and ISO standards. Specifications and design are subject to change without notice. All dimensions are given for DEVELON excavators equipped with standard tracks and the standard front as listed. Pictures of DEVELON excavators may show other than standard equipment. All dimensions are shown in inches. Respective metric dimensions are enclosed by parentheses. Rounding may impact specifications. DEVELON equipment is manufactured with a Quality Management System that is in compliance with ISO 9001:2008.

# Dimensions

		Standard Arm 31.5" (800 mm) TG Shoe (US20)	Long Arm 35.4" (900 mm) TG Shoe (US30)
Boom length		19' 4" (5900 mm)	
Arm length		9' 10" (3000 mm)	11' 6" (3500 mm)
Bucket type (SAE)		1.44 yd <sup>3</sup> (1.1 m <sup>3</sup> )	1.2 yd <sup>3</sup> (0.92 m <sup>3</sup> )
Track type		Fixed	
Tail swing radius	A <sub>1</sub>	10' 0" (3040 mm)	
Tail swing overhang (rear)	A <sub>2</sub>	2' 5" (725 mm)	
Tail swing overhang (side)	A <sub>3</sub>	4' 5" (1340 mm)	4' 3" (1290 mm)
Shipping height (boom)	B	9' 10" (2995 mm)	11' 1" (3380 mm)
Shipping height (hose)	C	10' 5" (3200 mm)	11' 7" (3555 mm)
Shipping length	D	33' 0" (10080 mm)	33' 2" (10105 mm)
Shipping width	E	11' 1" (3400 mm)	11' 5" (3500 mm)
Counterweight clearance	F	3' 8" (1110 mm)	
Cabin height	G	9' 9" (2995 mm)	
Upper structure width	H	8' 11" (2710 mm)	
Cabin height above house*	I	2' 9" (840 mm)	
Cabin width	J	3' 4" (1010 mm)	
Tumbler distance	K	12' 7" (3835 mm)	
Overall track length	L	15' 2" (4630 mm)	
Undercarriage width	M	11' 2" (3400 mm)	11' 5" (3500 mm)
Track gauge	N	8' 6" (2600 mm)	
Track shoe width	O	31.5" (800 mm)	35.4" (900 mm)
Track height*	P	3' 3" (990 mm)	
Car body clearance*	Q	1' 6" (450 mm)	

\*Without shoe grouser

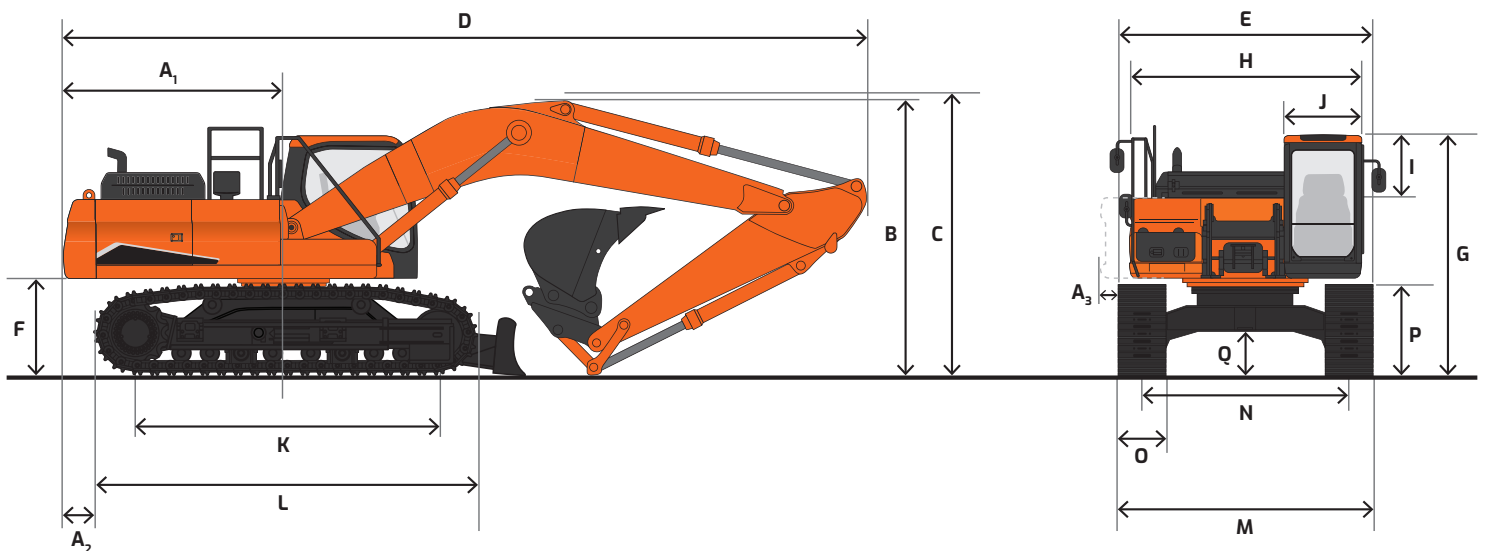

# Working Range

		Standard Arm 31.5" (800 mm) TG Shoe (US20)	Long Arm 35.4" (900 mm) TG Shoe (US30)
Boom length		19' 4" (5900 mm)	
Arm length		9' 10" (3000 mm)	11' 6" (3500 mm)
Bucket type (SAE, PCSA)		1.44 yd <sup>3</sup> (1.1 m <sup>3</sup> )	1.2 yd <sup>3</sup> (0.92 m <sup>3</sup> )
Track type		Fixed	
Max. digging reach	A	33' 5" (10175 mm)	34' 9" (10605 mm)
Max. digging reach (ground)	B	32' 9" (9995 mm)	34' 2" (10430 mm)
Max. digging depth	C	22' 4" (6810 mm)	23' 11" (7315 mm)
Max. loading height	D	23' 0" (7025 mm)	23' 6" (7170 mm)
Min. loading height	E	8' 6" (2600 mm)	6' 10" (2090 mm)
Max. digging height	F	31' 10" (9705 mm)	32' 2" (9820 mm)
Max. bucket pin height	G	27' 11" (8500 mm)	28' 4" (8640 mm)
Max. vertical wall depth	H	17' 1" (5200 mm)	18' 1" (5520 mm)
Max. radius vertical	I	23' 8" (7225 mm)	24' 8" (7520 mm)
Max. depth to 8' line	J	21' 8" (6615 mm)	23' 4" (7135 mm)
Min. radius to 8' line	K	9' 7" (2930 mm)	9' 7" (2945 mm)
Min. digging reach	L	2' 3" (690 mm)	7" (190 mm)
Min. swing radius	M	12' 3" (3720 mm)	12' 3" (3745 mm)
Bucket angle (DEG)	d	174°	
Digging force, bucket (PCSA)	ISO	37497 lbf. (17900 kgf)	
Digging force, arm		28219 lbf. (12800 kgf)	25794 lbf. (11700 kgf)
Operating weight		58960 lb. (26800 kg)	59563 lb. (27074 kg)
Ground pressure		7.8 psi (0.55 kg/cm <sup>2</sup> )	7.8 psi (0.55 kg/cm <sup>2</sup> )

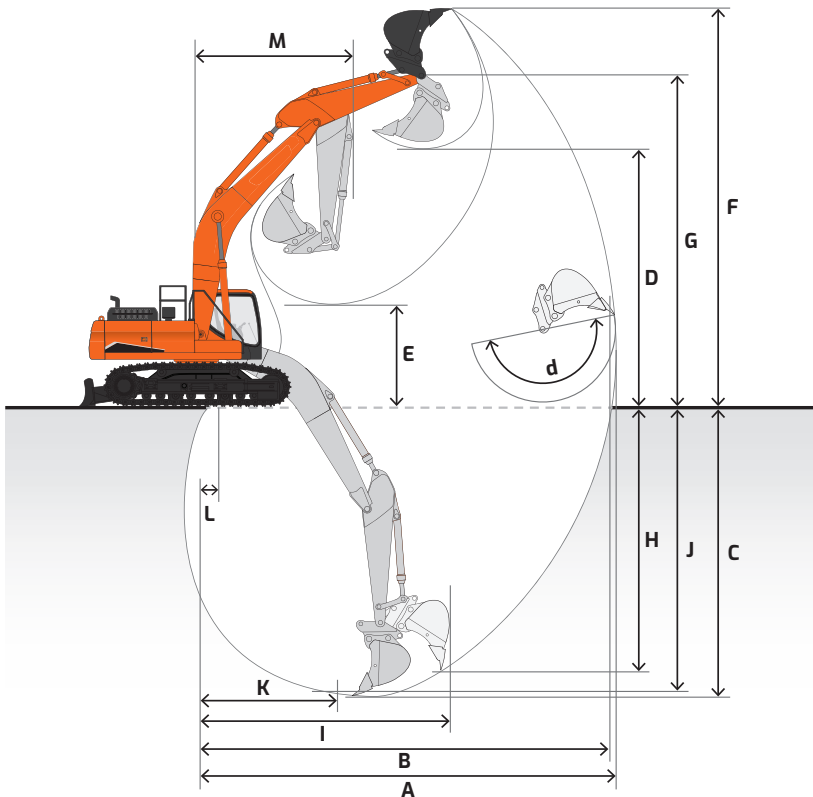

# Bucket

	Standard Arm (US20)	Long Arm (US30)		
<b>Boom</b>	19' 4" (5900 mm)			
<b>Arm</b>	9' 10" (3000 mm)	11' 5" (3500 mm)		
<b>Shoe size</b>	31.5" (800 mm)	35.4" (900 mm)		
<b>Track type</b>	Fixed			
<b>Mount</b>	Pin-on	Quick-coupler	Pin-on	Quick-coupler
<b>Counterweight</b>	12100 lb. (5500 kg)			

Bucket Type	Model	Capacity* yd <sup>3</sup> (m <sup>3</sup> )	Width in. (mm)	Weight lb. (kg)				
Heavy-duty	HD25-024	0.64 (0.49)	24 (610)	1726 (783)	A	A	A	A
	HD25-030	0.87 (0.67)	30 (762)	1897 (860)	A	A	A	A
	HD25-036	1.11 (0.85)	36 (914)	2099 (952)	A	A	A	A
	HD25-042	1.36 (1.04)	42 (1067)	2289 (1038)	A	A	A	A
	HD25-048	1.60 (1.22)	48 (1219)	2504 (1136)	B	B	B	B
Severe-duty	SD25-024	0.64 (0.49)	24 (610)	1850 (839)	A	A	A	A
	SD25-030	0.87 (0.67)	30 (762)	2102 (953)	A	A	A	A
	SD25-036	1.11 (0.85)	36 (914)	2285 (1036)	A	A	A	A
	SD25-042	1.36 (1.04)	42 (1067)	2477 (1124)	A	A	A	A
	SD25-048	1.60 (1.22)	48 (1219)	2713 (1231)	B	B	B	B
Ditching	DC250-048	0.97 (0.74)	48 (1219)	1703 (772)	A	A	A	A
	DC250-060	1.22 (0.93)	60 (1524)	2117 (960)	A	A	A	A
	HDC250-066	2.16 (1.65)	66 (1676)	3022 (1371)	C	C	C	C
	HDC250-072	2.58 (1.97)	72 (1829)	3206 (1454)	X	X	X	X

\*Capacity based on ISO 7451 and heaped with a 1:1 angle of repose

- Equipped with bolt-on wear shrouds
- Equipped with bolt-on teeth
- Equipped with bolt-on cutting edge

• These recommendations are given as a guide only and based on typical operating conditions.

#### Maximum Suitable Material Density

- A 3370 lb./yd<sup>3</sup> (2000 kg/m<sup>3</sup>)
- B 2700 lb./yd<sup>3</sup> (1600 kg/m<sup>3</sup>)
- C 1850 lb./yd<sup>3</sup> (1100 kg/m<sup>3</sup>)
- X Not Approved













Please consult with your DEVELON dealer to properly match buckets and attachments for the application.

# Lifting Capacity

 Rating over front     Rating over side or 360°

## DX255LC-7 US20

Boom: 19' 4" (5900 mm) | Arm: 9' 10" (3000 mm) | Counterweight: 12100 lb. (5500 kg) | 31.5" (800 mm) TG Shoes | Bucket: None | Unit: lb. (kg)

A (ft. or m) B (ft. or m)	5' (1.5 m)		10' (3.0 m)		15' (4.5 m)		20' (6.0 m)		25' (7.5 m)		Max. Reach		
													A
25' (7.5 m)							* 14120 (* 6418)	* 14120 (* 6418)			* 11290 (* 5131)		21.79' (6.64 m)
20' (6.0 m)							* 14410 (* 6550)	* 14410 (* 6550)	* 12520 (* 5722)	10840 (4970)	* 10680 (* 4855)	10420 (* 4736)	25.17' (7.67 m)
15' (4.5 m)							* 16080 (* 7309)	15020 (6827)	* 14680 (* 6672)	10680 (4855)	* 10600 (* 4818)	9050 (4114)	27.25' (8.31 m)
10' (3.0 m)					* 24020 (* 10918)	21720 (9873)	* 18450 (* 8386)	14330 (6514)	* 15770 (7168)	10360 (4709)	* 10930 (* 4968)	8360 (3800)	28.33' (8.63 m)
5' (1.5 m)					* 28420 (* 12918)	20380 (9264)	* 20750 (* 9432)	13670 (6214)	16230 (7377)	10020 (4555)	* 11670 (* 5305)	8110 (3686)	28.53' (8.70 m)
Ground Level		* 16050 (* 7295)	* 16050 (* 7295)	* 30430 (* 13832)	19690 (8950)	22190 (10086)	13220 (6009)	15950 (7250)	9780 (4445)	* 13000 (5909)	8280 (3764)	27.85' (8.49 m)	
-5' (-1.5 m)	* 18400 (* 8363)	* 18400 (* 8363)	* 27950 (* 12705)	* 27950 (* 12705)	* 30180 (* 13718)	19510 (8868)	21970 (9986)	13030 (5923)	15860 (7209)	9690 (4405)	14510 (6595)	8930 (4059)	26.25' (8.00 m)
-10' (-3.0 m)	* 30650 (* 13932)	* 30650 (* 13932)	* 38640 (* 17564)	38250 (* 17386)	* 27820 (* 12645)	19680 (8945)	* 20860 (* 9482)	13110 (5959)			* 16430 (7468)	10440 (4745)	23.5' (7.16 m)
-15' (-4.5 m)			* 30420 (* 13827)	* 30420 (* 13827)	* 22420 (* 10191)	20230 (9195)					* 16270 (* 7395)	14140 (6427)	19.12' (5.83 m)

A Distance from center of rotation  
B Height

NOTE: Lifting capacities are in compliance with SAE 1097 and ISO 10567. Machine in lifting mode with power boost turned on. Load point is the end of the arm. Rated loads shown do not exceed 75% of minimum tipping loads or 87% of hydraulic capacities. Rated loads marked with an asterisk (\*) are limited by hydraulic capacities. The least stable position is over the side. The total mass of machine includes the mass of the boom, arm, counterweight, all operating fluids and 165 lb. (75 kg) operator.

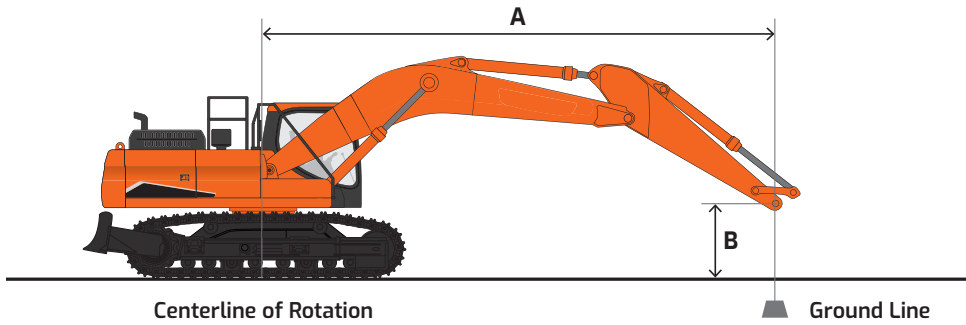















# Lifting Capacity

 Rating over front     Rating over side or 360°

## DX255LC-7 US30

Boom: 19' 4" (5900 mm) | Arm: 11' 5" (3500 mm) | Counterweight: 12100 lb. (5500 kg) | 35.4" (900 mm) TG Shoes | Bucket: None | Unit: lb. (kg)

A (ft. or m) B (ft. or m)	5' (1.5 m)		10' (3.0 m)		15' (4.5 m)		20' (6.0 m)		25' (7.5 m)		30' (9.0 m)		Max. Reach		
															A
25' (7.5 m)													* 10150 (* 4614)	* 10150 (* 4614)	23.61' (7.19 m)
20' (6.0 m)									* 13010 (* 5914)	12040 (5473)			* 9700 (* 4409)	* 9700 (* 4409)	26.76' (8.16 m)
15' (4.5 m)							* 14820 (* 6736)	* 14820 (* 6736)	* 13710 (* 6232)	11800 (5364)			* 9670 (* 4395)	9180 (4173)	28.73' (8.76 m)
10' (3.0 m)					* 22030 (* 10014)	* 22030 (* 10014)	* 17310 (* 7868)	15910 (7232)	* 14940 (* 6791)	11430 (5195)	* 10820 (* 4918)	8640 (3927)	* 9970 (* 4532)	8530 (3877)	29.76' (9.07 m)
5' (1.5 m)					* 26920 (* 12236)	22910 (10414)	* 19830 (* 9014)	15150 (6886)	* 16280 (7400)	11040 (5018)	* 12370 (5623)	8460 (3845)	* 10620 (* 4827)	8290 (3768)	29.94' (9.13 m)
Ground Level			* 18570 (* 8441)	* 18570 (* 8441)	* 29750 (* 13523)	21970 (9986)	* 21660 (* 9845)	14590 (6633)	16110 (7323)	10720 (4873)			* 11750 (* 5341)	8420 (3827)	29.30' (8.93 m)
-5' (-1.5 m)	* 17720 (* 8055)	* 17720 (* 8055)	* 27300 (* 20850)	* 27300 (* 20850)	* 30280 (* 13764)	21610 (9823)	22140 (10064)	14300 (6500)	15940 (7245)	10560 (4800)			13460 (* 6118)	9010 (4095)	27.78' (8.47 m)
-10' (-3.0 m)	* 27690 (* 12586)	* 27690 (* 12586)	* 38830 (* 17650)	* 38830 (* 17650)	* 28720 (* 13055)	21680 (9855)	* 21440 (* 9745)	14300 (6500)	16000 (7273)	10620 (4827)			15510 (7050)	10320 (4691)	25.19' (7.68 m)
-15' (-4.5 m)	* 40530 (* 18423)	* 40530 (* 18423)	* 34110 (* 15505)	* 34110 (* 15505)	* 24550 (* 11159)	22110 (10050)	* 17970 (* 8168)	14630 (6650)					* 15960 (* 7255)	13280 (6036)	21.20' (6.46 m)

A Distance from center of rotation  
B Height

NOTE: Lifting capacities are in compliance with SAE 1097 and ISO 10567. Machine in lifting mode with power boost turned on. Load point is the end of the arm. Rated loads shown do not exceed 75% of minimum tipping loads or 87% of hydraulic capacities. Rated loads marked with an asterisk (\*) are limited by hydraulic capacities. The least stable position is over the side. The total mass of machine includes the mass of the boom, arm, counterweight, all operating fluids and 165 lb. (75 kg) operator.

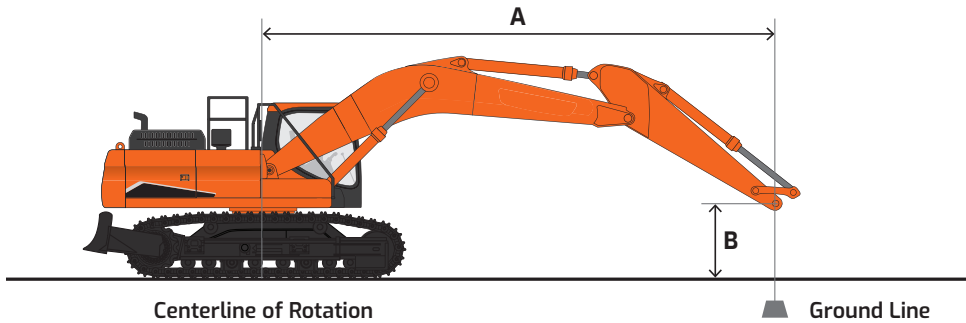

# Standard & Optional Equipment

■ Standard    ● Optional

## Engine

Emissions (EPA)	T4f
High-pressure common-rail (HPCR)	■
Turbo, waste gate (WGT)	■
Cooled exhaust gas recirculation (CEGR)	■
Diesel oxidation catalyst (DOC)	■
Selective catalyst reduction (SCR)	■
Diesel exhaust fluid (DEF)	■
Fuel filter with water separator	■
Coolant expansion tank	■
Dual element dry-type air filter with evacuator	■
Precleaner	■
Electronic engine control (ECU)	■
Auto idle	■
Auto shutdown (time-adjustable)	■
Overheat & low oil pressure engine protection	■
Block heater (110 V)	●
Water separator with heater	●
Fuel filler pump	●

## Hydraulic

Electronic Power Optimizing System (EPOS)	■
Variable axial piston main pump (tandem)	■
Cross-sensing pump control	■
Pilot-operated control valves	■
Gear pilot pump	■
Smart Power Control (SPC)	■
Variable-speed hydraulic cooling fan	■
Axial piston swing motor	■
Spring-applied hydraulic release brake, swing motor	■
Axial piston travel motor (high/low, auto)	■
Auxiliary hydraulics, one- & two-way piping	■
Auxiliary hydraulics, tilt/rotate piping	●
Adjustable auxiliary flow & pressure, 10 presets	■
Intelligent floating boom	●
Breaker filter	●
Boom & arm lock valves	●
Clamshell piping	●
Straight travel	●

## Controls

Joystick controls	■
Pattern control change valve (SAE, ISO)	■
Joystick attachment control	■
Switches/buttons	■
- Right (one-way, two-way, power boost)	
- Left (tilt/rotate, horn, one-touch decel)	
Foot pedal attachment control	■
Control stands	■
- Height adjustable	
- Sliding (fore/aft)	
- Tilting armrests	
Engine speed control dial	■
Travel pedals with hand levers	■
Straight travel pedal	●
Switches, console-mounted	■
- Starter button switch	
- Travel speed selector	
- Work light	
- Auxiliary mode switch	
Emergency stop switch	■
Power modes (P+, P, S, E)	■
Work modes (digging, lifting, breaker, shear)	■
Smart Power Control (SPC)	■
Jog dial display control	■
Wiper control panel	■
Audio control panel	■

## Cabin

Steel, all-weather & sound-suppressed	■
ROPS (ISO 12117-2:2008)	■
Viscous mount with spring reinforcement	■
Front window with wiper/washer	■
Tinted safety glass	■
Skylight top hatch with sun screen	■
Front window with sun screen	■
Pull-up type top front window	■
Removable lower front window with storage behind seat	■
Adjustable sliding side door window	■
Defrost, front window	■
Lockable doors	■
Seat	■
- Heated	
- Air suspension	
- 2" (51 mm) seat belt	■
- Adjustable height & recline	
- Adjustable fore/aft	
- Adjustable armrests	
Leatherette seat	●
- Heating & cooling	
- Air suspension	
- 2" (51 mm) seat belt	
- Adjustable height & recline	
- Adjustable fore/aft	
- Adjustable armrests	
3" (76 mm) seat belt	●
Control stands	■
- Height adjustable	
- Mounted to seat base	
Storage for operator's manuals	■
Mirrors	■
Fully automatic HVAC with ambient temperature sensor	■
8" multi-function LCD interactive display monitor	■
Cigarette lighter	■
Digital audio broadcasting stereo	■
Speakers (2)	■
Antenna, roof-mounted	■
Emergency breakout tool	■
Hot/cold beverage compartment	■
Power socket, 12 V & 24 V	■
Cup holder	■
Interior light	■
Coat hanger	■
Rain shield	●
Fog guard	●
Front window guard	●

## Electrical

System voltage – 24 V	■
Alternator – 24 V, 80 amp	■
Alternator – 24 V, 100 amp	■
2 x 12 V batteries, 150 AH reserve capacity, 950 CCA	■
Blade-type fuse panel	■
Main circuit breaker	■
Light, work (LED): machine (2), boom (2)	■
Light, work (LED): 6 cab top, front (4), rear (2)	●
Light, work (LED): 4 cab top, front (2), rear (2)	●
Rotating beacon	●
Overload warning alarm	●
Hour meter	■
Engine restart prevention system	■
Side view & rearview camera with LED lamps (3)	■
360° all-around view camera	●
Microphone & speaker	●
Ultrasonic Sensor	●
Laptop service port	■
Self-diagnostics system	■
Smart key (remote ignition key)	■
DEVELON Fleet Management	■

## Display Monitor & Warnings

Indicators	■
- Work modes (P+, P, S, E)	
- User/Service menu	
Gauges	■
- Fuel level	
- DEF level	
- Engine coolant temperature	
- Hydraulic oil temperature	
- Engine rpm	
- Battery voltage	■
- Hydraulic pump pressure	
- ECO	
- Digital clock	
- Trip meter	
- Hour meter	
- Fuel consumption	
Warning & indicator lights	■
- Seat belt	
- Error code	
- SCR warning	
- Check engine	
- Engine oil pressure	
- Engine pre-heat engaged	
- Radiator coolant level & temperature	
- Air filter	■
- Fuel level	
- DEF level – low	
- Water in fuel	
- Battery charge	
- Work lights on	
- Hydraulic oil temperature	
- Hydraulic charge pressure	
- Hydraulic pilot filter	
- Hydraulic return filter	
Swing alarm	■
Travel alarm	■
Buzzer	■
- Engine oil pressure	
- Coolant temperature	

## Undercarriage

Track guards & chains with adjusters	■
Track rollers, upper	2
Track rollers, lower	10
In-shoe motor protection	■
Shoes, triple grouser – 700 mm	●
Shoes, triple grouser – 800 mm	■
Shoes, triple grouser – 900 mm	●

## Other

Centralized lubrication	■
- Boom	
- Swing	
Handrails & service platforms	■
Skid-resistant steps & service platforms	■
Manuals	■
- Operation & Maintenance	
- Parts	
- AEM Safety Manual	
DEVELON Fleet Management 3-year subscription	■
Vandalism protection	■
- Lockable panels	
- Lockable fluid fill points	●
- Anti-theft protection (password)	
- Vandalism window cover mount	
Air Compressor	●

Certain specification(s) are based on engineering calculations and are not actual measurements. Specification(s) are provided for comparison purposes only and are subject to change without notice. Specification(s) for your individual DEVELON equipment will vary based on normal variations in design, manufacturing, operating conditions, and other factors. Pictures of DEVELON units may show other than standard equipment.

# Powered by Innovation

# DEVELON

A brand of HD Hyundai Infracore.

[na.develon-ce.com/dx255lc-7](http://na.develon-ce.com/dx255lc-7)

DX255LC-7 Crawler Excavator Spec Sheet  
Printed in the U.S.A.  
23906\_001\_D062123

©2023 HD Hyundai Infracore. All rights reserved.